

154

Catalogue

TV and Satellite solutions 2016

Products for the distribution of audio, video and data signals

Aerials

Electronic mast
and indoor equipment

Headends

Fibre optic solutions
and CATV systems

Multiswitches

Distribution components



Index

Fracarro Group	04
Services	05
TV Standards	06
TV and Satellite Solutions	
Aerials	11
Electronic mast and indoor equipment	47
Headends	63
Fibre optic solutions and CATV systems	99
Multiswitches	105
Distribution components	131
Index of products	151

Fracarro Group

The company

Established in 1933, Fracarro is today one of the most important companies in Europe in the field of reception and distribution of audio video data signals and active security.

The synergy between the two sectors allows Fracarro to propose integrated solutions for the creation of intelligent buildings and dwellings to connect and interact actively worldwide.

Our aim is to guarantee the supply of high quality products with particular care to all connected services dedicated to the operators within that sector.



Today the company is able to guarantee a comprehensive catalogue of systems in the sector of audio, video and data for the reception and distribution of AVD signals: terrestrial and satellite antennas, amplifiers, mixers, power supplies, headends and distribution components.

With the introduction of DTT and having extensive experience in foreign markets, Fracarro is considered a reference point for solutions relating to the introduction of new technology.

European directives conformity

Fracarro's products are compliant, if applicable, to the following European Directives:

- 2006/95/EC (LVD - Bassa Tensione)
- 2004/108/EC (EMC - Compatibilità Elettromagnetica)
- 1999/5/EC (RTTE - Apparatı radio e terminali di telecomunicazione)

As they exceeded tests specified in the technical harmonized standards, carried out by leading accredited laboratories.

Such products are identified by the CE marking.

More info about the Quality Policy on www.fracarro.com.



4

Web site and social network

The Fracarro website allows to be constantly updated on the news and the company's initiatives. In particular, the Technical Assistance section provides useful information to support operators in their professional activity, relying on a direct line with the headquarters staff.

Fracarro is also present in the major social network to be even closer to the professionals.

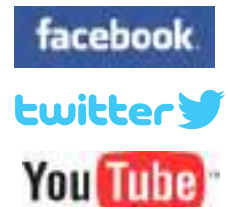

Technical assistance

Fracarro provides technical assistance to solve any installation problem in the fastest way. The service is available in each Fracarro company, with specialised staff ready to provide information or define projects.

Training

Fracarro has always been at the forefront in providing information to operators about available technology and is committed to giving training initiatives during exhibitions and road shows, working closely with clients and partners. As well as providing backup material and in depth information, the company is also preparing important training projects to guarantee professional growth for all field operators.

FRDesigner

Fracarro has developed FRDesigner, a software system which enables you to easily design a complete system for the reception and distribution of audio-video-data signals. All the information you need will be included for your project, from signal values to product costs and estimated manpower. Combining technical calculations and currency values with the highest accuracy, FRDesigner will edit a definitive and complete offer which you can submit easily to your customer.

Diamante, Diamantini, Aria, Solaria and Solea Towers, Villas, Porta Nuova Milano

Fibre Optic system

The complex, consisting of several buildings, including the Diamante skyscraper, is equipped with a Fracarro TV and Satellite system, realised with a cluster programmable headend (offices) and with a modular K Series headend (residential area).

The distribution of the signals in the residential area has been realised with mixed technologies, fiber optic and coaxial, while in office the innovative Home Fibre Fracarro has been used.

The numbers of the system:

- over 100 fibre links
- over 1400 sockets
- more than 35.000 metres of coax cable



Bosco verticale, Isola Milano

Fibre Optic system

Winner of the "International Highrise Award" in 2014 as the most beautiful and innovative skyscraper in the world, Bosco Verticale is equipped with a Fracarro TV and Satellite distribution system.

The installation is composed by an agile multicluster headend and by a K series headend for the reshaping of 2 in digital terrestrial satellite transponders. The system has been realised with mixed technology, fiber optic and coaxial.

The numbers of the system:

- over 800 sockets
- SAT signals also for PVR (My Sky)



Hotel Excelsior Venice Lido Resort, Venezia

IP-TV System

The prestigious Venetian hotel chose Fracarro to realise the new IPTV system, through which it has been possible to integrate different technologies and services into a single solution, with a significant simplification of the structure.

For the management of the signals the new generation HeadLine headend was used, composed of modules for the conversion of digital terrestrial and satellite signals in IP. The contents were then managed by the IT service with a distribution over LAN, without using the coaxial cables.



Advantages:

- Reduction of masonry works thanks to the fibre optic distribution. Ready for the connection with the hotel management software (PMS)
- Availability of TV and Satellite signals as well as Internet on every LAN ports of the hotel (wired, but also reached by wi-fi)
- Distribution of more than 100 Italian and foreign programs (free and pay)
- Remote control of headend, both for ordinary maintenance, for example the change of the channel list without intervention on the TV terminals or tablet, and the management of the anomalies.

TV standards

DTT world map

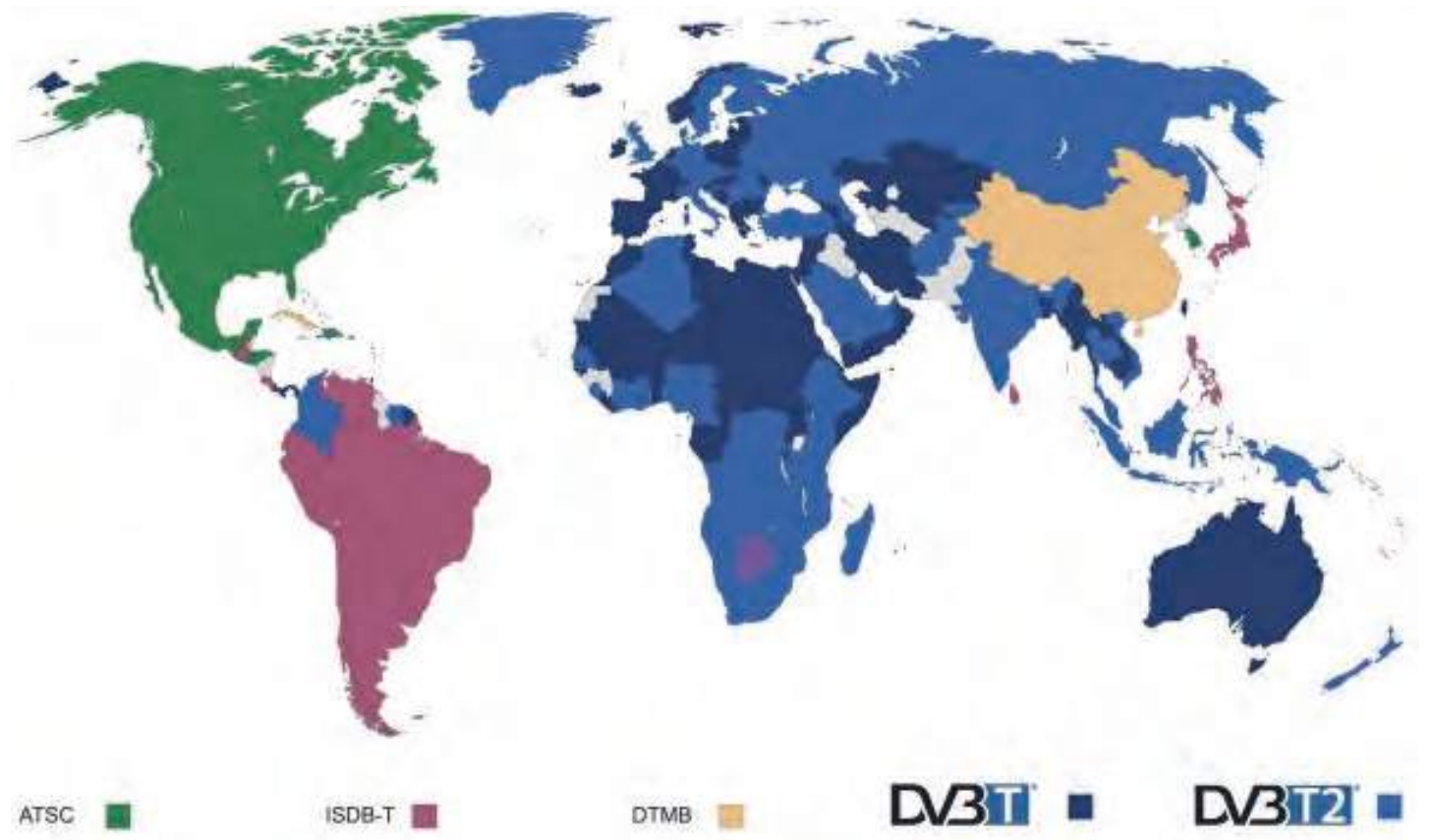

Digital Terrestrial Television Systems.

Blue indicates countries that have adopted or deployed DVB-T and DVB-T2. January 2013

Copyright 2012 DVB Project.

DVB and the DVB logo marks are registered trademarks of the DVB Project.

Source: www.dvb.org

Countries which have completed Analogue Switch Off (ASO)

Country	Standard	Compression	Country	Standard	Compression
Austria	DVB-T/DVB-T2	MPEG-2	Latvia	DVB-T/ DVB-T2	MPEG-4 AVC
Belgium	DVB-T	MPEG-2	Luxemburg	DVB-T	MPEG-2
Croatia	DVB-T	MPEG-2	Norway	DVB-T	MPEG-4 AVC
Czech rep.	DVB-T/DVB-T2	MPEG-2	Netherlands	DVB-T	MPEG-2
Denmark	DVB-T	MPEG-2/MPEG-4 AVC	Portugal	DVB-T	MPEG-4 AVC
Estonia	DVB-T/DVB-T2	MPEG-4 AVC	Slovak rep.	DVB-T/DVB-T2	MPEG-2
Finland	DVB-T/DVB-T2	MPEG-2	Slovenia	DVB-T	MPEG-4 AVC
France	DVB-T	MPEG-2/MPEG-4 AVC	Spain	DVB-T/DVB-T2	MPEG-2
Germany	DVB-T	MPEG-2	Sweden	DVB-T/DVB-T2	MPEG-2
Ireland	DVB-T	MPEG-2	Switzerland	DVB-T	MPEG-2
Italy	DVB-T/ DVB-T2	MPEG-4 AVC	UK	DVB-T/DVB-T2	MPEG-2
Lithuania	DVB-T/ DVB-T2	MPEG-4 AVC			

Sources: www.digitag.org - www.dvb.org (DTT deployment data at May 2013)

Main transmission standards

DTT	DVB-T	DVB-T2
Modulation	COFDM	COFDM
Number of sub carriers	2K, 8K	1K, 2K, 4K, 8K, 16K, 32K
Sub carriers modulation	QPSK , 16QAM, 64QAM	QPSK, 16QAM, 64QAM, 256QAM
FEC	1/2 , 2/3 , 3/4 , 5/6 , 7/8	1/2, 3/5, 2/3, 3/4, 4/5 , 5/6
Guard interval	1/4, 1/8, 1/16, 1/32	1/4, 19/256, 1/8, 19/128, 1/16, 1/32
Bandwidth	6, 7 or 8MHz	1.7, 5, 6, 7, 8, 10MHz
Maximum useful bit-rate	About 31.6Mbps	About 50Mbps
SAT	DVB-S	DVB-S2
Modulation	QPSK	QPSK, 8PSK, 16APSK, 32APSK
FEC	1/2 , 2/3 , 3/4 , 5/6 , 7/8	1/4, 1/3, 1/2, 3/5, 2/3, 3/4, 4/5, 5/6, 8/9, 9/10

Available bit rates for a DVB-T system in 8MHz channels

Modulation	Codification value	Guard interval				Modulation	Codification value	Guard interval			
		1/4	1/8	1/16	1/32			1/4	1/8	1/16	1/32
QPSK	1/2	4.98	5.53	5.85	6.03	64QAM	1/2	14.93	16.59	17.56	18.10
	2/3	6.64	7.37	7.81	8.04		2/3	19.91	22.12	23.42	24.13
	3/4	7.46	8.29	8.78	9.05		3/4	22.39	24.88	26.35	27.14
	5/6	8.29	9.22	9.76	10.05		5/6	24.88	27.65	29.27	30.16
	7/8	8.71	9.68	10.25	10.56		7/8	26.13	29.03	30.74	31.67
16QAM	1/2	9.95	11.06	11.71	12.06						
	2/3	13.27	14.75	15.61	16.09						
	3/4	14.93	16.59	17.56	18.10						
	5/6	16.59	18.43	19.52	20.11						
	7/8	17.42	19.35	20.49	21.11						

Note: the values in italics are in Mbps

TV standards

CCIR - Standard

Channel	Channel frequency MHz	Digital central frequency MHz	Analogue picture carrier MHz	Channel	Channel frequency MHz	Digital central frequency MHz	Analogue picture carrier MHz	Channel	Channel frequency MHz	Digital central frequency MHz	Analogue picture carrier MHz
Standard B + G Europe											
Band I				S23	318-326	322	319.25	Band V			
E 2	47-54	50.5	48.25	S24	326-334	330	327.25	E38	606-614	610	607.25
E 3	54-61	57.5	55.25	S25	334-342	338	335.25	E39	614-622	618	615.25
E 4	61-68	64.5	62.25	S26	342-350	346	343.25	E40	622-630	626	623.25
Band S				S27	350-358	354	351.25	E41	630-638	634	631.25
S 1	104-111	107.5	105.25	S28	358-366	362	359.25	E42	638-646	642	639.25
S 2	111-118	114.5	112.25	S29	366-374	370	367.25	E43	646-654	650	647.25
S 3	118-125	121.5	119.25	S30	374-382	378	375.25	E44	654-662	658	655.25
S 4	125-132	128.5	126.25	S31	382-390	386	383.25	E45	662-670	666	663.25
S 5	132-139	135.5	133.25	S32	390-398	394	391.25	E46	670-678	674	671.25
S 6	139-146	142.5	140.25	S33	398-406	402	399.25	E47	678-686	682	679.25
S 7	146-153	149.5	147.25	S34	406-414	410	407.25	E48	686-694	690	687.25
S 8	153-160	156.5	154.25	S35	414-422	418	415.25	E49	694-702	698	695.25
S 9	160-167	163.5	161.25	S36	422-430	426	423.25	E50	702-710	706	703.25
S10	167-174	170.5	168.25	S37	430-438	434	431.25	E51	710-718	714	711.25
Band III				S38	438-446	442	439.25	E52	718-726	722	719.25
E 5	174-181	177.5	175.25	S39	446-454	450	447.25	E53	726-734	730	727.25
E 6	181-188	184.5	182.25	S40	454-462	458	455.25	E54	734-742	738	735.25
E 7	188-195	191.5	189.25	S41	462-470	466	463.25	E55	742-750	746	743.25
E 8	195-202	198.5	196.25	Band IV				E56	750-758	754	751.25
E 9	202-209	205.5	203.25	E21	470-478	474	471.25	E57	758-766	762	759.25
E10	209-216	212.5	210.25	E22	478-486	482	479.25	E58	766-774	770	767.25
E11	216-223	219.5	217.25	E23	486-494	490	487.25	E59	774-782	778	775.25
E12	223-230	226.5	224.25	E24	494-502	498	495.25	E60	782-790	786	783.25
Band S				E25	502-510	506	503.25	LTE			
S11	230-237	233.5	231.25	E26	510-518	514	511.25	E61	790-798	794	791.25
S12	237-244	240.5	238.25	E27	518-526	522	519.25	E62	798-806	802	799.25
S13	244-251	247.5	245.25	E28	526-534	530	527.25	E63	806-814	810	807.25
S14	251-258	254.5	252.25	E29	534-542	538	535.25	E64	814-822	818	815.25
S15	258-265	261.5	259.25	E30	542-550	546	543.25	E65	822-830	826	823.25
S16	265-272	268.5	266.25	E31	550-558	554	551.25	E66	830-838	834	831.25
S17	272-279	275.5	273.25	E32	558-566	562	559.25	E67	838-846	842	839.25
S18	279-286	282.5	280.25	E33	566-574	570	567.25	E68	846-854	850	847.25
S19	286-293	289.5	287.25	E34	574-582	578	575.25	E69	854-862	858	855.25
S20	293-300	296.5	294.25	E35	582-590	586	583.25				
S21	302-310	306	303.25	E36	590-598	594	591.25				
S22	310-318	314	311.25	E37	598-606	602	599.25				

CCIR - Standard

Channel	Channel frequency MHz	Digital central frequency MHz	Analogue picture carrier MHz	Channel	Channel frequency MHz	Digital central frequency MHz	Analogue picture carrier MHz	Channel	Channel frequency MHz	Digital central frequency MHz	Analogue picture carrier MHz
Standard D Russia - OIRT				Standard I South Africa				Standard K French overseas territories			
R 1	48.5-56.5	52.5	49.75	Band III				Band III			
R 2	58-66	62	59.25	I 4	174-182	178	175.25	K 4	174-182	178	175.25
R 3	76-84	80	77.25	I 5	182-190	186	183.25	K 5	182-190	186	183.25
Band II				I 6	190-198	194	191.25	K 6	190-198	194	191.25
R 4	84-92	88	85.25	I 7	198-206	202	199.25	K 7	198-206	202	199.25
R 5	92-100	96	93.25	I 8	206-214	210	207.25	K 8	206-214	210	207.25
Band III				I 9	214-222	218	215.25	K 9	214-222	218	215.25
R 6	174-182	182	175.25	I 10	222-230	226	223.25				
R 7	182-190	190	183.25	I 11	230-238	234	231.25				
R 8	190-198	198	191.25	I (12)	238-246	242	239.25				
R 9	198-206	206	199.25	I 13	246-254	250	247.25				
R 10	206-214	214	207.25								
R 11	214-222	222	215.25								
R 12	222-230	230	223.25								

Level conversion table (75Ω)

mV	dBμV	dBm	mV	dBμV	dBm
0.10	40	-68.8	12.59	82	-26.8
0.12	42	-66.8	15.85	84	-24.8
0.16	44	-64.8	19.95	86	-22.8
0.20	46	-62.8	25.12	88	-20
0.25	48	-60.8	31.62	90	-18.8
0.31	50	-58.8	39.81	92	-16.8
0.39	52	-56.8	50.12	94	-14.8
0.50	54	-54.8	63.10	96	-12.8
0.63	56	-52.8	79.43	98	-10.8
0.79	58	-50.8	100.00	100	-8.8
1.00	60	-48.8	125.89	102	-6.8
1.26	62	-46.8	158.49	104	-4.8
1.58	64	-44.8	199.53	106	-2.8
2.00	66	-42.8	251.19	108	-0.8
2.51	68	-40.8	316.23	110	1.2
3.16	70	-38.8	398.11	112	3.2
3.98	72	-36.8	501.19	114	5.2
5.01	74	-34.8	630.96	116	7.2
6.31	76	-32.8	794.33	118	9.2
7.94	78	-30.8	1000.00	120	11.2
10.00	80	-28.8			

Comparison noise figure and signal-noise ratio

Noise figure	Kto	3.0	3.5	4.0	4.5	5.0	5.5	6.0	6.5	7.0	7.5	8.0
	dB	4.8	5.4	6.0	6.5	7.0	7.4	7.8	8.1	8.4	8.7	9.0
Noise voltage at 75 Ohm	dBμV	7.1	7.7	8.3	8.8	9.3	9.7	10.1	10.4	10.7	11.0	11.3



Aerials

FM & DAB aerials

FM & DAB series	12
-----------------	----

VHF aerials

Band III wideband	13
High performance band III wideband	15
SIGMA V2 HD	16

LTE aerials

TAU LTE series	17
BLU LTE series	18
ALPHA LTE series	19
SIGMA LTE series	20
LAMBDA LTE series	21

KIT LTE

21

UHF aerials

SIGMA series	22
BLU series	23
BLU PLUS series	24
ALPHA series	25
OMEGA	26
TAU series grid reflector	27
TAU series tube reflector	28
Yagi channel grouped	29
Yagi wideband	30
Yagi fullband	31
Panel aerials	32

UHF+VHF aerials

SIGMA COMBO LTE	33
BLU COMBO LTE	33

LOG-PERIODIC aerials

LP series with F connector	34
LP series	37

MASTS

38

MASTS BRACKETS

39

SAT DISHES

PENTA series	42
OFFSET series 60-85 cm	43
OFFSET series 100-150 cm	44

LNB's

Universal LNB's	45
SCR LNB's	45

KIT SAT

46

DiSEqC switches

46

Line amplifier

46

Dual feed support

46

Aerials

FM & DAB aerials

FM & DAB series

Different designs

Reception of FM radio signals

Used for MATV, SMATV and IRS installations.



Item		ANTI200A	FM OMNI	DAB
Code		213001	213009	213010
Elements	No.	1	1	1
Channels		FM	FM	DAB
Bandwidth	MHz	87.5-108	87.5-108	216-240
Maximum gain	dBi	2.1	2.1	2.1
Return loss	dB	-16	< -6	-16
Beamwidth (-3dB)	°	360	360	360
Wind load at 120Km/h (720N/m ²)	Kg (N)	3 (29.43)	2.7 (26.46)	2 (19.62)
Connector	type	F	F	F
Impedance	Ohm	75	75	75
Maximum mast Ø	mm	60	60	60
Dimensions (L x W)	cm	96x77 (H x L)	63x10.5	59x8 (H x L)
Packaging				
Quantity	Pcs	10	10	8
Unit weight	Kg	0.9	0.84	0.54
Total weight	Kg	10.6	8.6	4.4
Accessories				
Horizontal polarisation			included	
Horizontal polarisation with tilt adj.			N/A	
Auxiliary boom			N/A	

Gain (x: frequency MHz, y: gain ISO dBi) and **Pattern** (@105MHz for ANTI200A and FMOMNI, @230MHz for DAB)

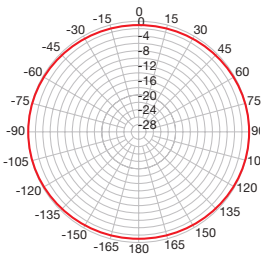
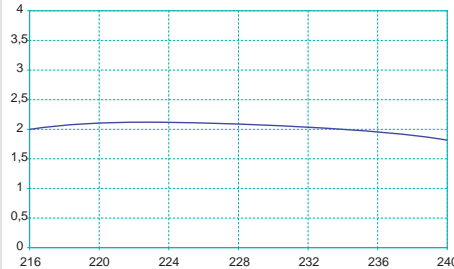
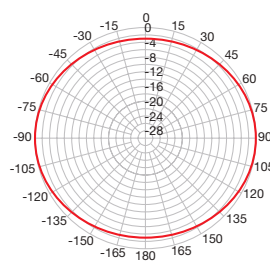
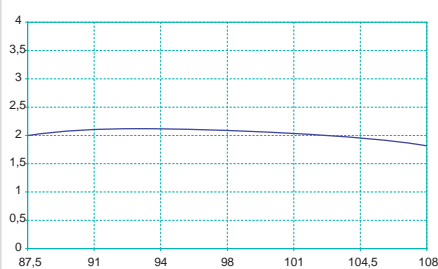

ANTI200A - FM OMNI

DAB



VHF aerials

Band III wideband

High quality pre-assembled aerials
High gain and excellent directivity
Superior electrical and mechanical qualities



4E512_F



6E512_F

Item		4E512_F	6E512_F
Code		218706	218718
Elements	No.	4	6
Band		III	III
Channels		E5-E12	E5-E12
Bandwidth	MHz	174-230	174-230
Maximum gain	dBi	7	10
Front-to-back ratio	dB	16	18
Return loss	dB	-10	-12
Beamwidth (-3dB)	°	±31	±24
Wind load at 120Km/h (720N/m2)	Kg (N)	2.0 (19.62)	3.0 (29.13)
Connector	type	F	F
Impedance	Ohm	75	75
Maximum mast Ø	mm	60	60
Dimensions (L x W)	cm	108x83	181x82
Quantity	pcs	20	20
Unit weight	Kg	0.33	0.36
Total weight	Kg	15.6	20.2
Accessories			
Horizontal polarisation			included
Horizontal polarisation with tilt adj.			PVZ-60
Vertical polarisation			PV10
Vertical polarisation with tilt adj.			PV10
Auxiliary boom			N/A

Gain (x: frequency MHz, y: gain ISO dBi) and **Pattern** (@200MHz)

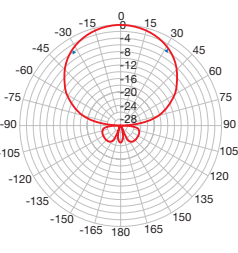
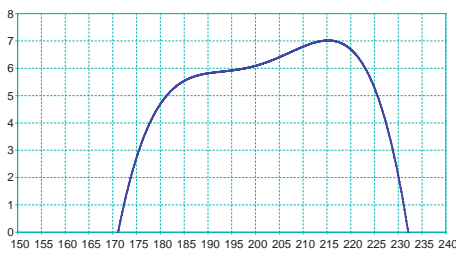

4E512_F

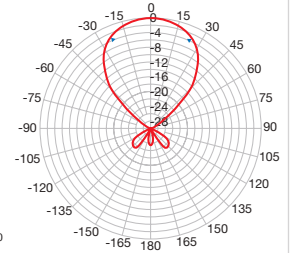
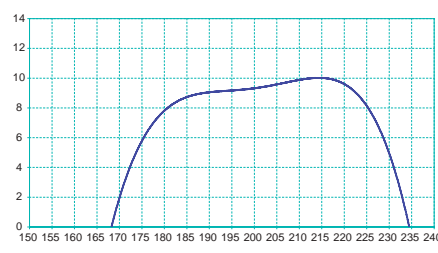

6E512_F



Aerials

VHF aerials

Band III wideband

High quality and exclusive design
High gain
F connector
Mast clamp with adjustable zenith
Ease of installation and transport



Item	TERZA 6HD	
Code	213008	
Elements	No.	6
Band	III	
Channels	E5-E12	
Bandwidth	MHz	174-230
Maximum gain	dBi	11
Front-to-back ratio	dB	25
Return loss	dB	-15
Beamwidth (-3dB)	°	±26
Wind load at 120Km/h (720N/m2)	Kg (N)	3.8 (37.24)
Connector	type	F
Impedance	Ohm	75
Maximum mast Ø	mm	60
Dimensions (L x W)	cm	119 x 86
Quantity	pcs	10
Unit weight	Kg	1.2
Total weight	Kg	12
Accessories		
Horizontal polarisation	Included	
Horizontal polarisation with tilt adj.	MEC3603G - MEC3603Z	
Vertical polarisation	Included	
Vertical polarisation with tilt adj.	MEC3603G - MEC3603Z	
Auxiliary boom	CA2	

Gain (x: frequency MHz, y: gain ISO dBi) and **Pattern** (@200MHz)

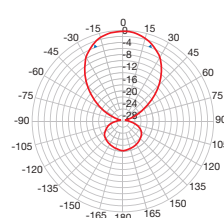
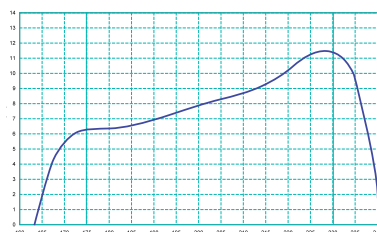

TERZA 6HD



VHF aerials

High performance band III wideband

Patent protected design
High gain, optimised impedance, excellent directivity
Superior electrical and mechanical qualities
Pre-assembled



BLV4F



BLV6F

Item		BLV4F	BLV6F
Code		218038	218058
Elements	No.	4	6
Band		III	III
Channels		E5-E12	E5-E12
Bandwidth	MHz	174-230	174-230
Maximum gain	dBi	10.5	13
Front-to-back ratio	dB	20	24
Return loss	dB	-23	-22
Beamwidth (-3dB)	°	±31	±24
Wind load at 120Km/h (720N/m ²)	Kg (N)	3.0 (29.43)	4.5 (44.14)
Connector	type	F	F
Impedance	Ohm	75	75
Maximum mast Ø	mm	60	60
Dimensions (L x W)	cm	64 x 87	149 x 87
Quantity	pcs	10	3
Unit weight	Kg	1.23	2
Total weight	Kg	14.5	6
Accessories			
Horizontal polarisation			included
Horizontal polarisation with tilt adj.			included
Vertical polarisation			PV10
Vertical polarisation with tilt adj.			PV10
Auxiliary boom			N/A

Gain (x: frequency MHz, y: gain ISO dBi) and **Pattern** (@200MHz)

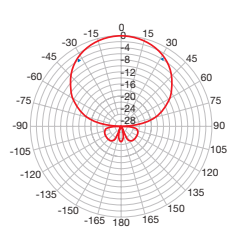
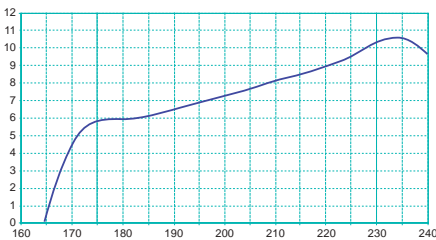

BLV4F

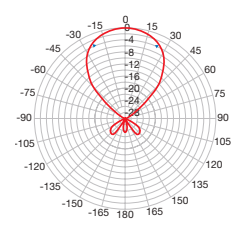
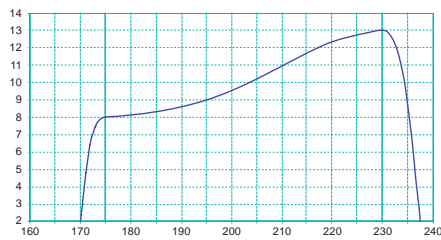

BLV6F



Aerials

VHF aerials

SIGMA V2 HD

Exclusive patented design
Equipped with circular director elements
Compact length
Pre-assembled

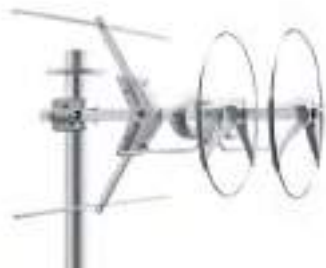

Item	SIGMA V2 HD	
Code	213203	
Elements	No.	2
Band	VHF	
Channels	E5-E12	
Bandwidth	MHz	174-230
Maximum gain	dBi	11.5
Front-to-back ratio	dB	>25
Return loss	dB	-12
Beamwidth (-3dB)	°	±25
Wind load at 120Km/h (720N/m2)	Kg (N)	10 (98)
Connector	type	F
Impedance	Ohm	75
Maximum mast Ø	mm	60
Dimensions (L x W)	cm	76 x 100.4
Quantity	pc	1
Unit weight	Kg	2.76
Total weight	Kg	2.76
Accessories		
Horizontal polarisation	included	
Horizontal polarisation with tilt adj.	included	
Vertical polarisation	included	
Vertical polarisation with tilt adj.	included	
Auxiliary boom	N/A	

Gain (x: frequency MHz, y: gain ISO dBi) and Pattern (@200MHz)

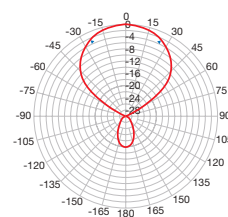
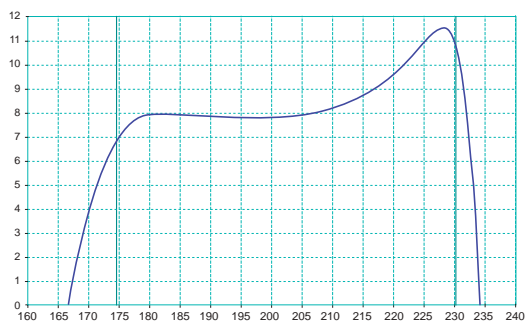

SIGMA V2 HD



LTE aerials

TAU LTE series

Yagi aerials with F connector
 Ideal for single or small MATV systems
 Steel boom
 Pre-assembled



Item		TAU LTE KILLER	TAU LTE KILLER +
Code	dB	213103	213104
Elements	No.	7	7
Band		UHF	UHF
Channels		E21-E60	E21-E60
Bandwidth	MHz	470-790	470-790
Maximum gain	dBi	14	14
Front-to-back ratio	dB	38	38
Return loss	dB	-18	-18
Beamwidth (-3dB)	°	±30	±30
Wind load at 120Km/h (720N/m2)	Kg (N)	5,3 (51.94N)	5,3 (51.94N)
Connector	type	F	F
Impedance	Ohm	75	75
Maximum mast Ø	mm	60	60
Dimensions (L x W)	cm	1170 x 497	1170 x 497
Quantity	pcs	1	1
Unit weight	Kg	1,75	1,75
Total weight	Kg	1,9	1,9
Accessories			
Horizontal polarisation			included
Horizontal polarisation with tilt adj.			included
Vertical polarisation			included
Vertical polarisation with tilt adj.			included
Auxiliary boom			N/A

Gain (x: frequency MHz, y: gain ISO dBi) and **Pattern** (@790MHz)

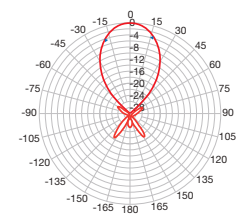
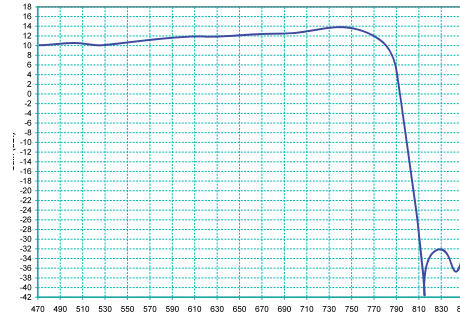
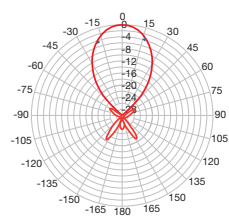
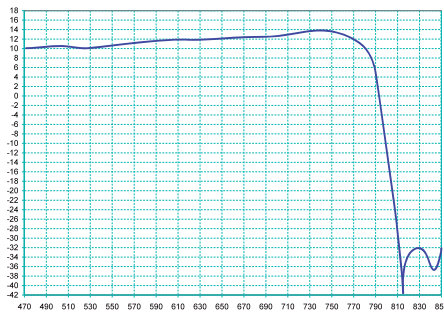

TAU LTE KILLER

TAU LTE KILLER +



Aerials

LTE aerials

BLU LTE series

F connector
Excellent directivity and gain
Superb electrical specifications
Pre-assembled

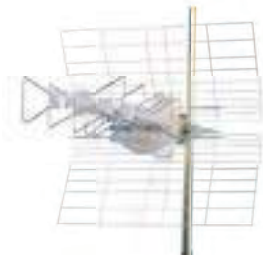

BLU 5HD LTE



BLU 10HD LTE

Item		BLU 5HD LTE	BLU 10HD LTE
Code		217910	217909
Elements	No.	5	10
Band		UHF	
Channels		E21-E60	E21-E60
Bandwidth	MHz	470-790	470-790
Maximum gain	dBi	14	16
Front-to-back ratio	dB	30	30
Return loss	dB	-16	-16
Beamwidth (-3dB)	°	±25	±22
Wind load at 120Km/h (720N/m ²)	Kg (N)	5,7 (55,86)	7,2 (70,56)
Connector	type	F	F
Impedance	Ohm	75	75
Maximum mast Ø	mm	60	60
Dimensions (L x W)	cm	84x50	119x50
Quantity	pcs	10	10
Unit weight	Kg	1,75	2,22
Total weight	Kg	19,4	24,6
Accessories			
Horizontal polarisation			included
Horizontal polarisation with tilt adj.			included
Vertical polarisation			included
Vertical polarisation with tilt adj.			included
Auxiliary boom			N/A

Gain (x: frequency MHz, y: gain ISO dBi) and Pattern (@790MHz)

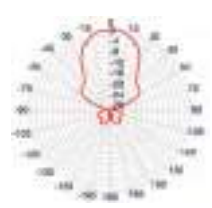
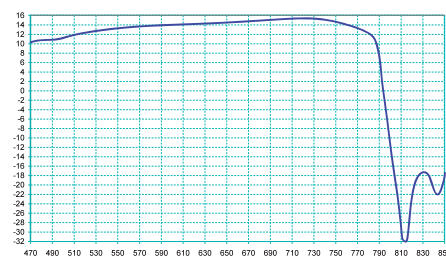
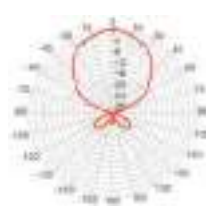
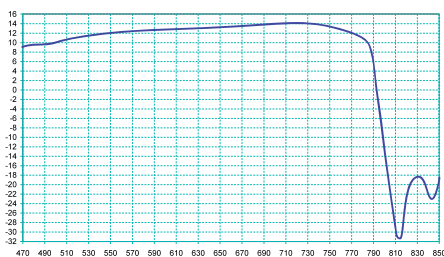

BLU 5HD LTE

BLU 10HD LTE

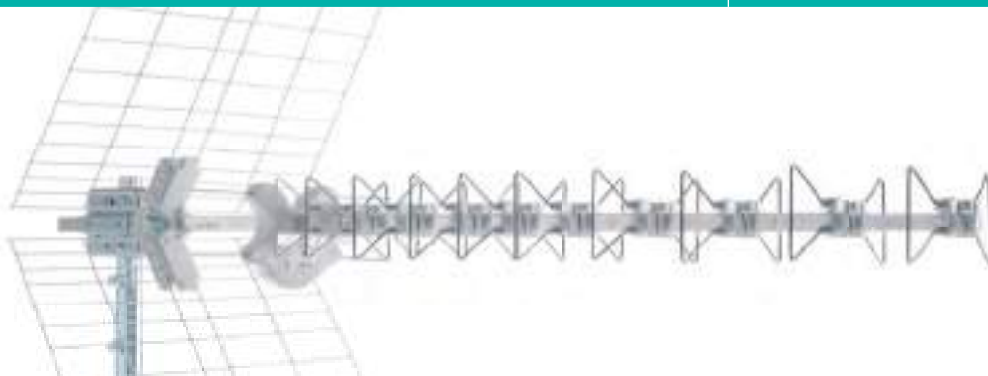

LTE aerials

ALPHA LTE series

Fracarro extends its ranges of Loop Yagi Antenna with the ALPHA Series, with a very high gain on the useful band. ALPHA aerials are completely pre-assembled and can be installed quickly and easily without any other tools

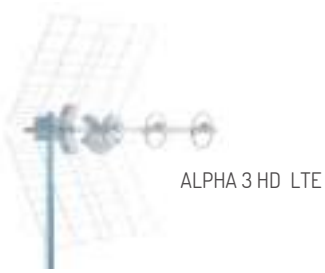

Item		ALPHA 3 HD LTE	ALPHA 5 HD LTE
Code		213217	213218
Elements	No.	3	5
Band		UHF	
Channels		E21-E60	E21-E60
Bandwidth	MHz	470-790	470-790
Maximum gain	dBi	13	14
Front-to-back ratio	dB	38	38
Return loss	dB	-18	-18
Beamwidth (-3dB)	°	±25	±22
Wind load at 120Km/h (720N/m2)	Kg (N)	7,7 (75,46)	5,7 (55,86)
Connector	type	F	F
Impedance	Ohm	75	75
Maximum mast Ø	mm	60	60
Dimensions (L x W)	cm	71 x 50	81 x 50
Quantity	pcs	10	10
Unit weight	Kg	1,8	2,77
Total weight	Kg	20,3	31
Accessories			
Horizontal polarisation			included
Horizontal polarisation with tilt adj.			included
Vertical polarisation			included
Vertical polarisation with tilt adj.			included
Auxiliary boom			N/A

Gain (x: frequency MHz, y: gain ISO dBi) and **Pattern** (@790MHz)

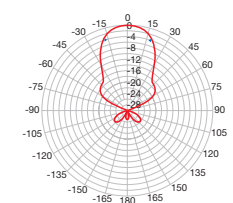
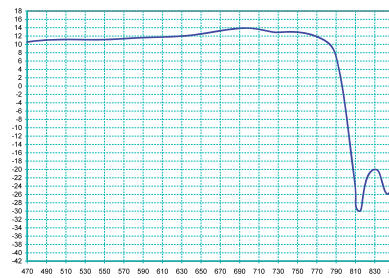
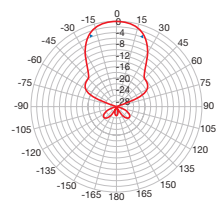
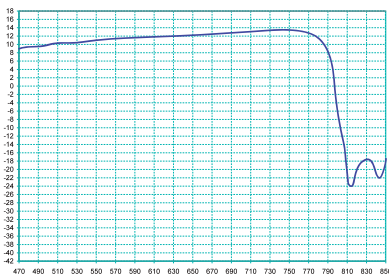

ALPHA 3 HD LTE

ALPHA 5 HD LTE

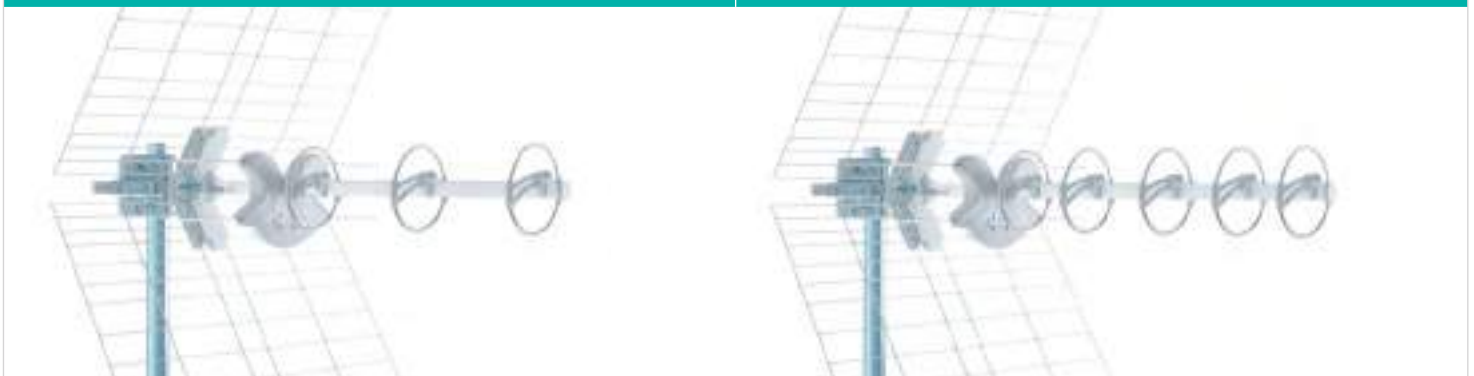

Aerials

LTE aerials

SIGMA LTE series

F connector
Ideal for single or small MATV systems
Steel boom
Pre-assembled



SIGMA 6HD LTE
SIGMA6HD LTE700

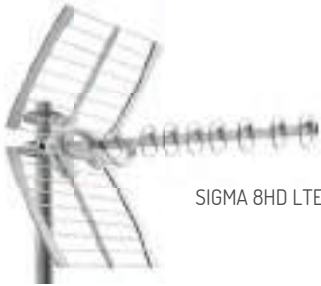

SIGMA 8HD LTE

Item	SIGMA 6HD LTE	SIGMA6HD LTE700	SIGMA 8HD LTE
Code	213219	213224	213213
Elements	No. 6	6	8
Band			
Channels	E21-E60	E21-E48	E21-E60
Bandwidth	MHz 470-790	470-649	470-790
Maximum gain	dBi 15	12	16
Front-to-back ratio	dB 32	32	32
Return loss	dB -18	-18	-18
Beamwidth (-3dB)	° ±18	±18	±17
Wind load at 120Km/h (720N/m2)	Kg (N) 23 (225,4)		
Connector	type F		
Impedance	Ohm 75		
Maximum mast Ø	mm 60		
Dimensions (L x W)	cm 92 x 62,5	92 x 62,5	119 x 62,5
Quantity	pcs 4	4	4
Unit weight	Kg 2,3	2,3	2,77
Total weight	Kg 12	12	16,8
Accessories			
Horizontal polarisation	included		
Horizontal polarisation with tilt adj.	included		
Vertical polarisation	included		
Vertical polarisation with tilt adj.	included		
Auxiliary boom	N/A		

Gain (x: frequency MHz, y: gain ISO dBi) and Pattern (@790MHz)

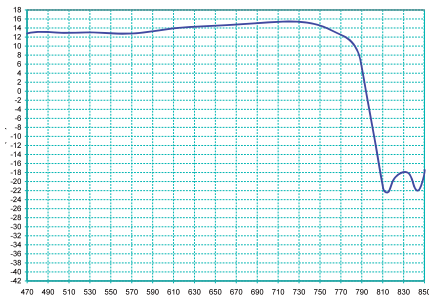

SIGMA 6HD LTE

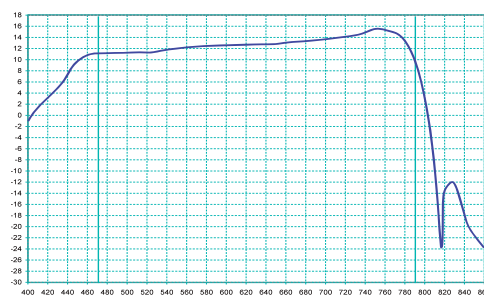
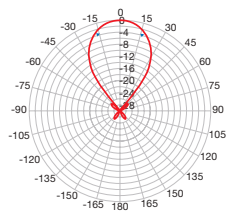

SIGMA 8HD LTE

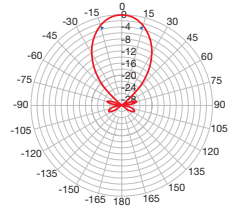

Gain (x: frequency MHz, y: gain ISO dBi) and Pattern (@790MHz)



SIGMA6HD LTE700

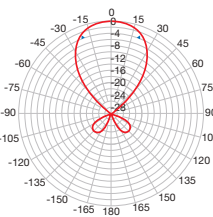

LTE aerials

LAMBDA LTE series

High performance aerials with F connector. The design of the connector cap and dipole clamp offer great protection. They are characterised by their excellent mechanical reflector sturdiness, high front-to-back ratio, good return loss and high gain. Mast clamp and joints of the boom are pre-assembled for easy installation. These aerials are also equipped with large wing nut bolt screws for excellent clamping.

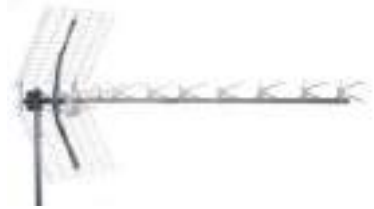

LAMBDA 9 LTE



LAMBDA 14 LTE

Item		LAMBDA 9 LTE	LAMBDA 14 LTE
Code		213057	213058
Elements	No.	9	14
Band		UHF	UHF
Channels		E21-E60	E21-E60
Bandwidth	MHz	470-790	470-790
Maximum gain	dBi	14.5	16
Front-to-back ratio	dB	24	26
Return loss	dB	-12	-14
Beamwidth (-3dB)	°	+/- 26	+/- 20
Wind load at 120Km/h (720N/m2)	Kg (N)	15 (147.15)	17.5 (171.67)
Connector	type	F	F
Impedance	Ohm	75	75
Maximum mast Ø	mm	55	55
Dimensions (L x W)	cm	152x50	177x50
Quantity	Pcs	1	1
Unit weight	Kg	2.72	3.38
Total weight	Kg	2.72	3.38
Accessories			
Horizontal polarisation		Included	+/- 20
Horizontal polarisation with tilt adj.		Included	17.5 (171.67)
Vertical polarisation		Included	F
Vertical polarisation with tilt adj.		Included	75
Auxiliary boom		N/A	Included

Gain (x: frequency MHz, y: gain ISO dBi) and **Pattern** (@790MHz)

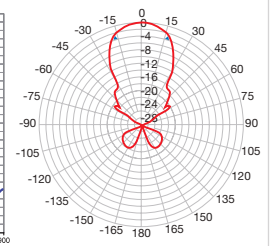
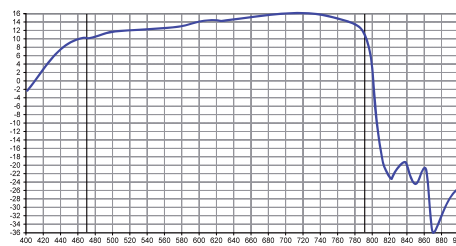
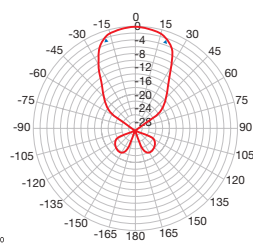
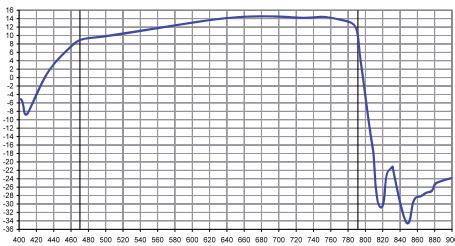

LAMBDA 9 LTE

LAMBDA 14 LTE

Kit LTE

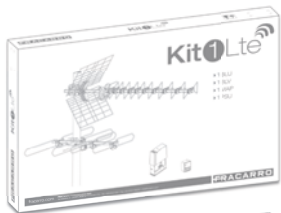

Item	Code	Description
KIT 1 LTE	217921	Composed by 1 BLU10HD LTE + 1 BLV4F + 1 MAP54ILTE + 1 MINIPOWER12P
KIT 2 LTE	217922	Composed by 2 BLU10HD LTE + 1 BLV4F + 1 MBJ3640LTE
KIT 3 LTE	217923	Composed by 2 BLU10HD LTE + 1 MAP54ILTE + 1 MINIPOWER12P
KIT 4 LTE	217924	Composed by 1 BLU10HD LTE + 1 MAP54ILTE + 1 MINIPOWER12P
KIT 5 LTE	217925	Composed by 1 TAU KILLER LTE + 1 TERZA 6HD + 1 MAP54ILTE + 1 MINIPOWER12P
KIT 6 LTE	217926	Composed by 1 BLU 5 HD LTE + 1 TERZA 6HD + 1 MAP313LTE + 1 MINIPOWER12P
KIT 7 LTE	217927	Composed by 1 BLU 10 HD LTE + 1 TERZA 6HD + 1 MAP313LTE + 1 MINIPOWER12P
KIT 8 LTE	217928	Composed by 1 SIGMA 6HD LTE + 1 BLV6F + 1 MAP206LTE + 1 MINIPOWER12P
KIT 10 LTE	217930	Composed by 1 SIGMA 6HD LTE + 1 BLV6F + 1 MAP54ILTE + 1 MINIPOWER12P
KIT 11 LTE	217931	Composed by 2 SIGMA 6HD LTE + 1 MAP313LTE + 1 MINIPOWER12P
KIT 12 LTE	217932	Composed by 2 SIGMA 6HD LTE + 1 MAP54ILTE + 1 MINIPOWER12P
KIT 13 LTE	217933	Composed by 1 BLU COMBO LTE + 1 MAP115LTE + 1 MINIPOWER12P

Aerials

UHF aerials

SIGMA series

Wideband loop Yagi aerials

F connector

Original patented design

Particular directivity and maximum gain

Completely pre-assembled

Quick and easy installation without any tools



SIGMA 6HD

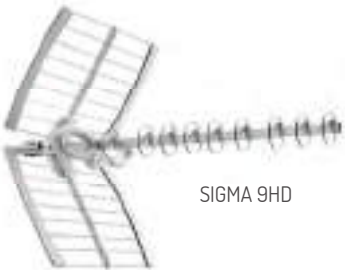

SIGMA 9HD

Item		SIGMA 6HD	SIGMA 6PWR HD	SIGMA 9HD
Code		213201	213209	213208
Elements	No.	6	6	9
Band		UHF	UHF	UHF
Channels		E21-E69	E21-E69	E21-E69
Bandwidth	MHz	470-862	470-862	470-862
Maximum gain	dBi	17	31	18.5
Front-to-back ratio	dB	32	32	32
Return loss	dB	-18	-18	-18
Beamwidth (-3dB)	°	±18	±18	±17
Wind load at 120Km/h (720N/m ²)	Kg (N)	23 (225.4)	23 (225.4)	23 (225.4)
Connector	type	F	F	F
Impedance	Ohm	75	75	75
Maximum mast Ø	mm	60	60	60
Dimensions (L x W)	cm	92 x 63	92 x 62.5	130 x 62.5
Quantity	pcs	4	1	4
Unit weight	Kg	2.3	2.3	3.3
Total weight	Kg	12	2.9	16.8
Accessories				
Horizontal polarisation			included	
Horizontal polarisation with tilt adj.			included	
Vertical polarisation			included	
Vertical polarisation with tilt adj.			included	
Auxiliary boom			N/A	

Gain (x: frequency MHz, y: gain ISO dBi) and Pattern (@862MHz)

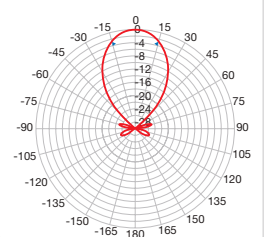
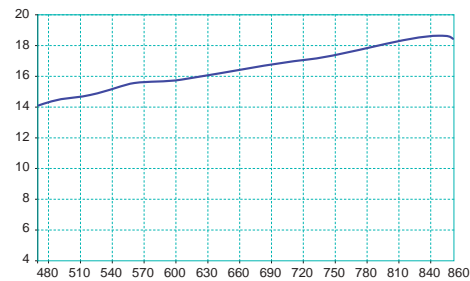
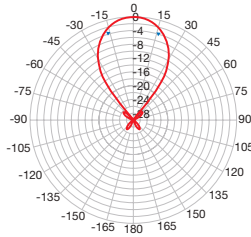
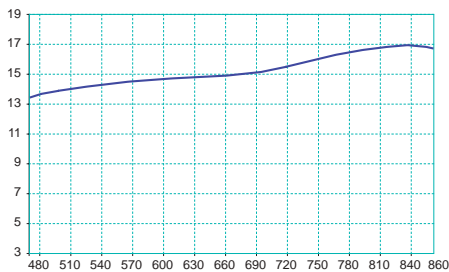

SIGMA 6HD

SIGMA 9HD



Item	Code	Description
SIGMA PWR HD	213204	<p>Also available an active UHF dipole for SIGMA Series aerials.</p> <ul style="list-style-type: none"> • The Sigma radiator contains an active dipole which substitutes an additional amplifier • 31dB max. equalised gain on the whole UHF band. Can be adjusted by using PSU200R power supply (see page 59) • Low "noise figure": <2.5dB • Low consumption: 26mA

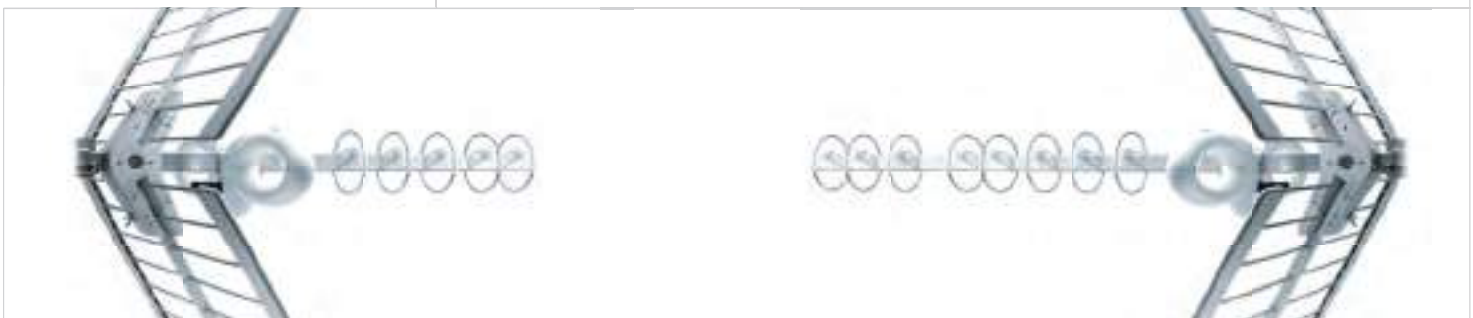

UHF aerials

BLU series

- Biconical aerial
- Superb electrical specifications
- Excellent directivity and gain
- Extremely robust antenna
- Completely pre-assembled
- Quick and easy installation without any tools

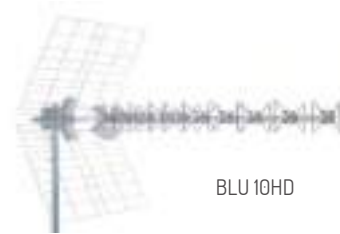
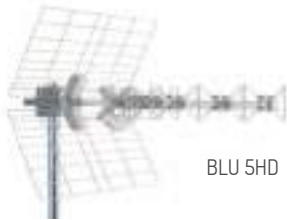

Item		BLU 5HD	BLU 10HD	BLU 10B4	BLU 10B5	BLU 22HD
Code		217901	217902	217903	217904	217905
Elements	No.	5	10	10	10	22
Band		UHF	UHF	IV	V	UHF
Channels		E21-E69	E21-E69	E21-E37	E37-E69	E21-E69
Bandwidth	MHz	470-862	470-862	470-606	606-862	470-862
Maximum gain	dBi	15	16	13	16	19
Front-to-back ratio	dB	30	30	27	28	30
Return loss	dB	-16	-16	-20	-22	-18
Beamwidth (-3dB)	°	±25	±22	±22	±22	±17
Wind load at 120Km/h (720N/m ²)	Kg (N)	5.7 (55.86)	7.2 (70.56)	7.2 (70.56)	7.2 (70.56)	12.2 (119.56)
Connector	type	F				
Impedance	Ohm	75				
Maximum mast Ø	mm	60				
Dimensions (L x W)	cm	84x50	119x50	122x50	119x50	242x50
Quantity	pcs	10	10	10	10	1
Unit weight	Kg	1.72	2.27	2.52	2.28	3.57
Total weight	Kg	17.20	22.70	25.20	22.80	3.54
Accessories						
Horizontal polarisation					included	
Horizontal polarisation with tilt adj.					included	
Vertical polarisation					included	
Vertical polarisation with tilt adj.					included	
Auxiliary boom					N/A	included

Gain (x: frequency MHz, y: gain ISO dBi) and **Pattern** (@862MHz)

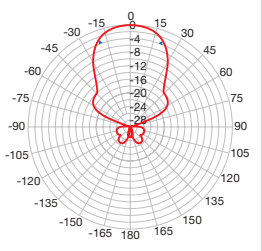
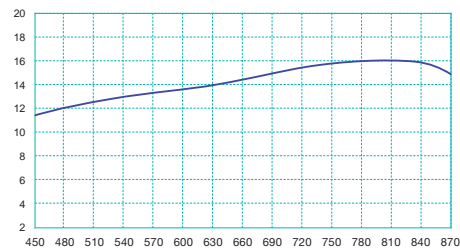
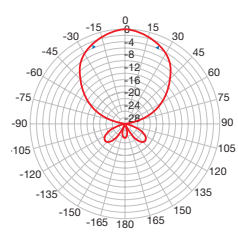
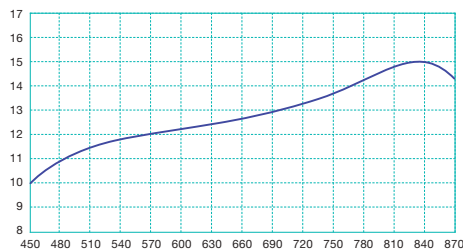

BLU 5HD

BLU 10HD

Gain (x: frequency MHz, y: gain ISO dBi) and **Pattern** (@862MHz)

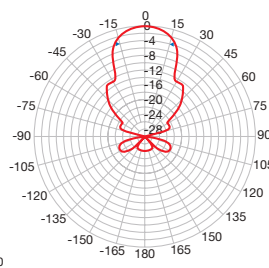
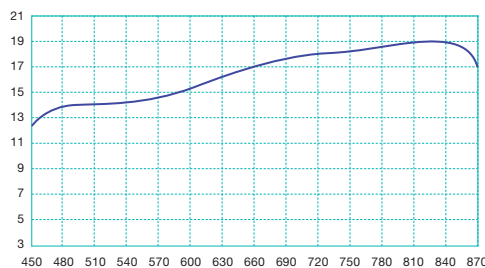

BU 22HD

Aerials

UHF aerials

BLU PLUS series

Pre-assembled aerial with F connector and excellent performance: high gain, high directivity and very good return loss.

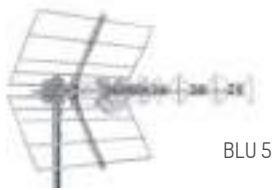

BLU 5



BLU 10

Item		BLU 5	BLU 10
Code		217906	217907
Elements	No.	5	10
Band		UHF	UHF
Channels		E21-E69	E21-E69
Bandwidth	MHz	470-862	470-862
Maximum gain	dBi	15	16
Front-to-back ratio	dB	32	30
Return loss	dB	-18	-16
Beamwidth (-3dB)	°	±23	±21
Wind load at 120Km/h (720N/m ²)	Kg (N)	7.7 (75.46)	9.2 (90.16)
Connector	type	F	F
Impedance	Ohm	75	75
Maximum mast Ø	mm	60	60
Dimensions (L x W)	cm	84X50	119X50
Quantity	pcs	8	10
Unit weight	Kg	1.55	2.02
Total weight	Kg	12.40	20.20
Accessories			
Horizontal polarisation			included
Horizontal polarisation with tilt adj.			included
Vertical polarisation			included
Vertical polarisation with tilt adj.			included
Auxiliary boom			N/A

Gain (x: frequency MHz, y: gain ISO dBi) and Pattern (@862MHz)

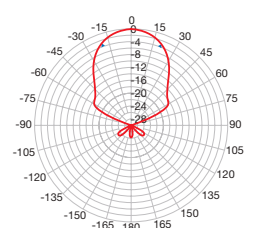
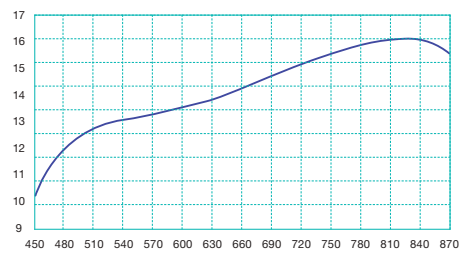
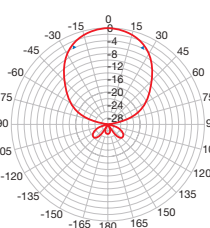
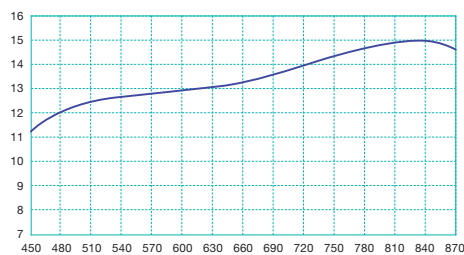

BLU 5

BLU 10

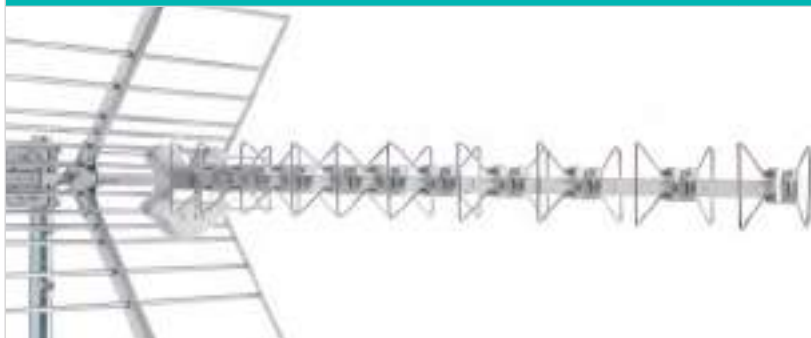

UHF aerials

ALPHA series

Loop Yagi Antenna
 Very high gain on the useful band
 Completely pre-assembled
 Quick and easy installation without any tools



Item		ALPHA 3HD	ALPHA 5HD
Code		213211	213212
Elements	No.	3	5
Band		UHF	UHF
Channels		E21-E69	E21-E69
Bandwidth	MHz	470-862	470-862
Maximum gain	dBi	13	14
Front-to-back ratio	dB	38	38
Return loss	dB	-18	-18
Beamwidth (-3dB)	°	±25	±22
Wind load at 120Km/h (720N/m2)	Kg (N)	5.7 (55.86)	5.7 (55.86)
Connector	type	F	F
Impedance	Ohm	75	75
Maximum mast Ø	mm	60	60
Dimensions (L x W)	cm	71x50	81x50
Quantity	pcs	10	10
Unit weight	Kg	1,8	1,94
Total weight	Kg	18	19,4
Accessories			
Horizontal polarisation			included
Horizontal polarisation with tilt adj.			included
Vertical polarisation			included
Vertical polarisation with tilt adj.			included
Auxiliary boom			N/A

Gain (x: frequency MHz, y: gain ISO dBi) and **Pattern** (@862MHz)

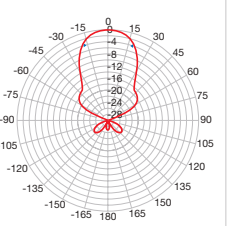
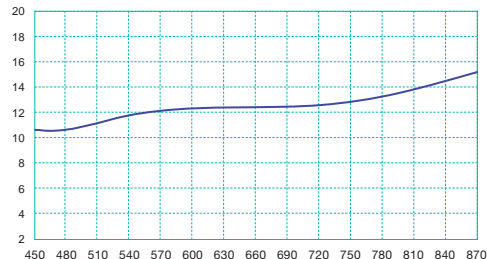
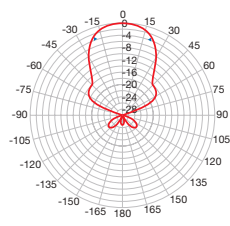
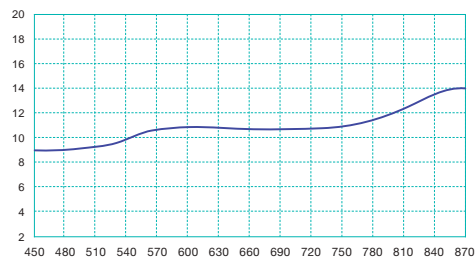

ALPHA 3HD

ALPHA 5HD



Aerials

UHF aerials

OMEGA

Excellent performance Yagi aerials
High mechanical sturdiness
High gain, high directivity and excellent front-to-back ratio.



Item	OMEGA8	
Code	213022	
Elements	No.	8
Band	UHF	
Channels	E21-E69	
Bandwidth	MHz	470-862
Maximum gain	dBi	16
Front-to-back ratio	dB	32
Return loss	dB	-18
Beamwidth (-3dB)	°	±22
Wind load at 120Km/h (720N/m ²)	Kg (N)	5.5 (53.95)
Connector	type	F
Impedance	Ohm	75
Maximum mast Ø	mm	60
Dimensions (L x W)	cm	107x58
Quantity	pcs	2
Unit weight	Kg	1.78
Total weight	Kg	3.56
Accessories		
Horizontal polarisation	included	
Horizontal polarisation with tilt adj.	included	
Vertical polarisation	included	
Vertical polarisation with tilt adj.	included	
Auxiliary boom	CA2	

Gain (x: frequency MHz, y: gain ISO dBi) and **Pattern** (@862MHz)

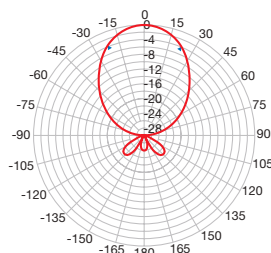
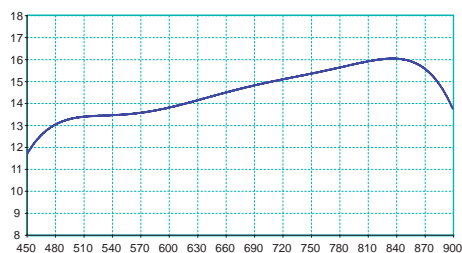

OMEGA8



UHF aerials

TAU series grid reflector

Yagi aerials with F connector.
Ideal for single or small MATV systems.
Steel boom, elements and reflector guarantee mechanical sturdiness.
Pre-assembled for easy installation.

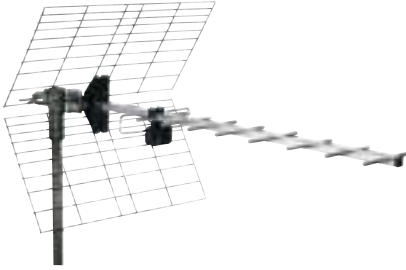

Item		TAU11/45	TAU11/4	TAU11/5
Code		213101	213096	213097
Elements	No.	8	8	8
Band		UHF	IV	V
Channels		E21-E69	E21-E37	E38-E69
Bandwidth	MHz	470-862	470-606	606-862
Maximum gain	dBi	12.5	13.5	12
Front-to-back ratio	dB	28	31	30
Return loss	dB	-16	-20	-17
Beamwidth (-3dB)	°	±23	±23	±23
Wind load at 120Km/h (720N/m ²)	Kg (N)	3.2 (31.39)	3.7 (36.29)	3.2 (31.39)
Connector	type	F	F	F
Impedance	Ohm	75	75	75
Maximum mast Ø	mm	60	60	60
Dimensions (L x W)	cm	97x50	115x50	87x50
Quantity	pcs	10	10	10
Unit weight	Kg	1.28	1.3	1.18
Total weight	Kg	14.8	15	13.8
Accessories				
Horizontal polarisation			included	
Horizontal polarisation with tilt adj.			included	
Vertical polarisation			included	
Vertical polarisation with tilt adj.			included	
Auxiliary boom			N/A	

Gain (x: frequency MHz, y: gain ISO dBi) and **Pattern** (UHF @862MHz)

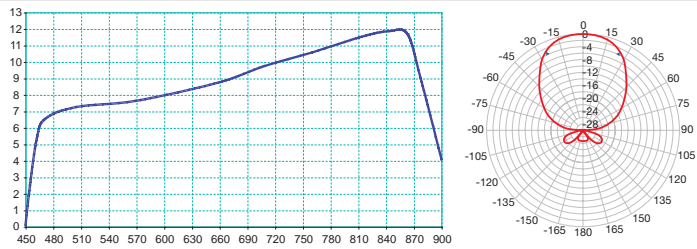

TAU11/45

Gain (x: frequency MHz, y: gain ISO dBi) and **Pattern** (IV @600MHz)

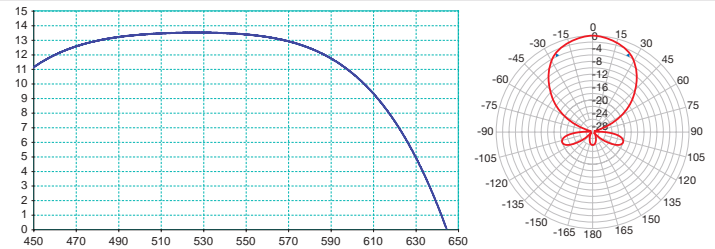

TAU11/4

Gain (x: frequency MHz, y: gain ISO dBi) and **Pattern** (V @862MHz)

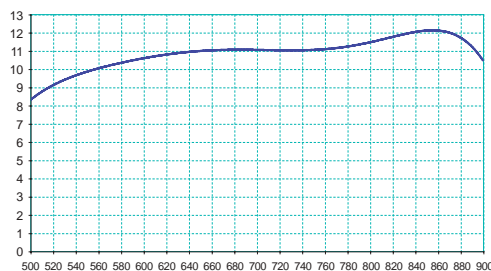

TAU11/5

Aerials

UHF aerials

TAU series tube reflector

Yagi aerials with F connector.

Ideal for single or small MATV systems.

Steel boom, elements and reflector guarantee mechanical sturdiness.

Pre-assembled for easy installation.



Item		TAU15/45	TAU15/4	TAU15/5
Code		213100	213094	213095
Elements	No.	8	8	8
Band		UHF	IV	V
Channels		E21-E69	E21-E37	E38-E69
Bandwidth	MHz	470-862	470-606	606-862
Maximum gain	dBi	12	13.5	11
Front-to-back ratio	dB	24	24	28
Return loss	dB	-14	-20	-16
Beamwidth (-3dB)	°	±25	±25	±25
Wind load at 120Km/h (720N/m ²)	Kg (N)	2.8 (27.46)	3.3 (32.37)	2.8 (27.46)
Connector	type	F	F	F
Impedance	Ohm	75	75	75
Maximum mast Ø	mm	60	60	60
Dimensions (L x W)	cm	98x42	115x42	87x42
Quantity	pcs	10	10	10
Unit weight	Kg	1	1.06	0.96
Total weight	Kg	12	12.6	11.6
Accessories				
Horizontal polarisation			included	
Horizontal polarisation with tilt adj.			included	
Vertical polarisation			included	
Vertical polarisation with tilt adj.			included	
Auxiliary boom			N/A	

Gain (x: frequency MHz, y: gain ISO dBi) and Pattern (UHF @862MHz)

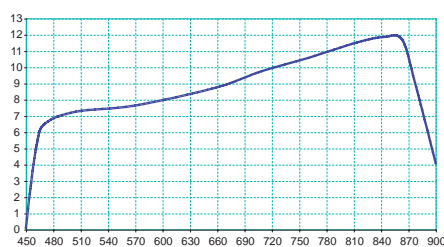

TAU15/45

Gain (x: frequency MHz, y: gain ISO dBi) and Pattern (IV @600MHz)

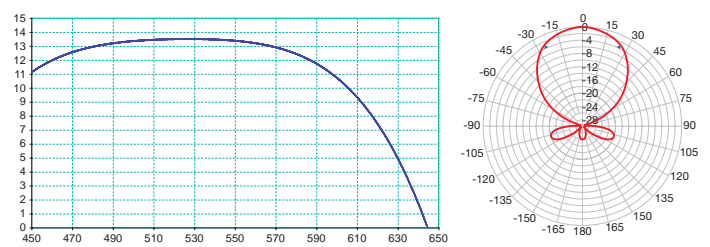

TAU15/4

Gain (x: frequency MHz, y: gain ISO dBi) and Pattern (V @862MHz)

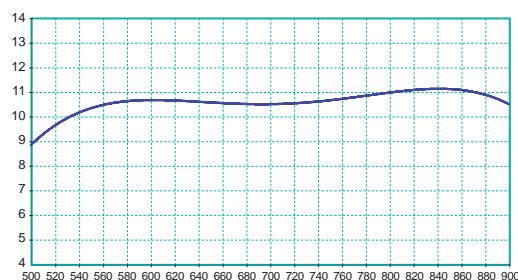

TAU15/5

UHF aerials

Yagi channel grouped

Good electrical performances
High selectivity
High mechanical sturdiness



Item		10F2734	10F3546		
Code		219532	219541		
Elements	No.	10	10		
Channels		E27-E34	E35-E46		
Bandwidth	MHz	518-582	582-678		
Maximum gain	dBi	15	16		
Front-to-back ratio	dB	25	30		
Return loss	dB	-23	-21		
Beamwidth (-3dB)	°	±21	±20		
Wind load at 120Km/h (720N/m2)	Kg (N)	2.6 (25.48)	2.4 (23.52)		
Connector	type	F	F		
Impedance	Ohm	75	75		
Maximum mast Ø	mm	42	42		
Dimensions (L x W)	cm	111x32	110x28		
Quantity	pcs	20	20		
Unit weight	Kg	0.7	0.62		
Total weight	Kg	14.4	12.8		
Accessories					
Mast Ø	mm	42	60	42	60
Horizontal polarisation		Included	PVZ-60	Included	PVZ-60
Horizontal polarisation with tilt adj.		PVZ-60	PVZ-60	PVZ-60	PVZ-60
Vertical polarisation		Included	PVZ-60	Included	PVZ-60
Vertical polarisation with tilt adj.		PVZ-60	PVZ-60	PVZ-60	PVZ-60
Auxiliary boom				N/A	

Gain (x: frequency MHz, y: gain ISO dBi) and **Pattern** (@560MHz)

Gain (x: frequency MHz, y: gain ISO dBi) and **Pattern** (@650MHz)

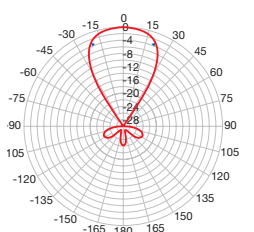
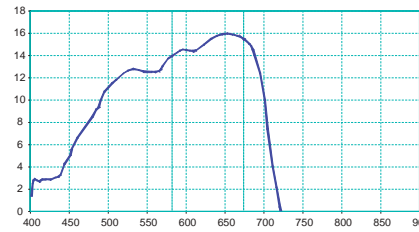
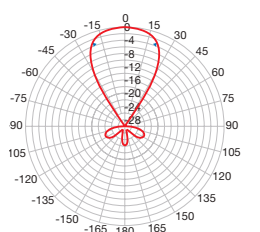
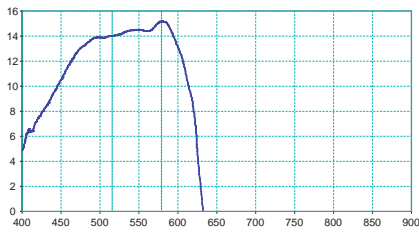

10F2734

10F3546

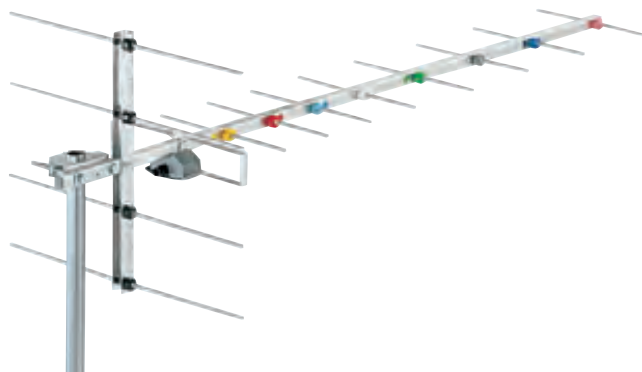

Aerials

UHF aerials

Yagi wideband

Yagi aerials with F connector.
Suitable for receiving full band IV, V or UHF.
Good electrical performance
Small practical packaging for easy installation,
transport and storage



Item		10BL4F	10BL5F	10BL45F			
Code		219406	219407	219446			
Elements	No.	10	10	10			
Band		IV	V	UHF			
Channels		E21-E37	E38-E69	E21-E69			
Bandwidth	MHz	470-606	606-862	470-862			
Maximum gain	dBi	14	13.5	12.5			
Front-to-back ratio	dB	27	22	24			
Return loss	dB	-22	-17	-16			
Beamwidth (-3dB)	°	±24	±27	±28			
Wind load at 120Km/h (720N/m ²)	Kg (N)	2.8 (27.46)	2.3 (22.56)	2.3 (22.56)			
Connector	type	75	75	75			
Impedance	Ohm	42	42	42			
Maximum mast Ø	mm	135x36	103x28	94x36			
Dimensions (L x W)	cm	20	20	20			
Quantity	pcs	0.752	0.612	0.625			
Unit weight	Kg	18.04	15.24	15.5			
Total weight	Kg	12	12.6	11.6			
Accessories							
Mast Ø	mm	42	60	42	60	42	60
Horizontal polarisation		Included	PVZ-60	Included	PVZ-60	Included	PVZ-60
Horizontal polarisation with tilt adj.					PVZ-60		
Vertical polarisation		Included	PVZ-60	Included	PVZ-60	Included	PVZ-60
Vertical polarisation with tilt adj.					PVZ-60		
Auxiliary boom							N/A

Gain (x: frequency MHz, y: gain ISO dBi) and Pattern (UHF @600MHz)

Gain (x: frequency MHz, y: gain ISO dBi) and Pattern (IV @862MHz)

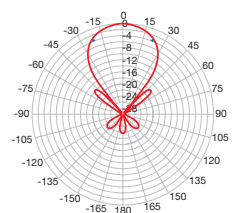
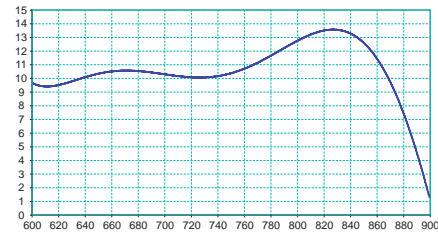
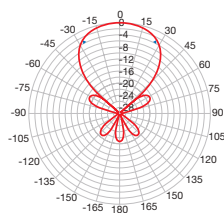
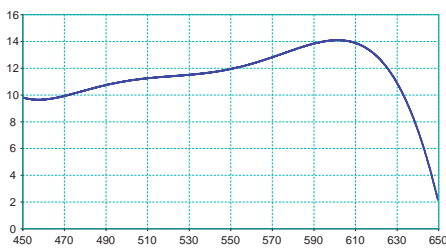

10BL4F

10BL5F

Gain (x: frequency MHz, y: gain ISO dBi) and Pattern (V @862MHz)

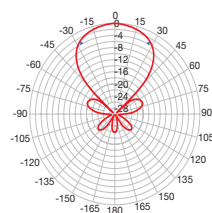
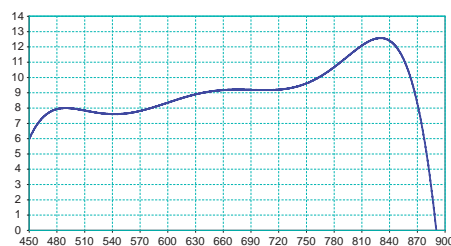

10BL45F

UHF aerials

Yagi fullband

Yagi aerials with F connector.
 Suitable for receiving full band IV, V or UHF.
 Good electrical performance
 Small practical packaging for easy installation,
 transport and storage



Item		10RD45F	
Code		219546	
Elements	No.	10	
Band		UHF	
Channels		E21-E69	
Bandwidth	MHz	470-862	
Maximum gain	dBi	13	
Front-to-back ratio	dB	24	
Return loss	dB	-20	
Beamwidth (-3dB)	°	±26	
Wind load at 120Km/h (720N/m ²)	Kg (N)	2.5 (24.52)	
Connector	type	F	
Impedance	Ohm	75	
Maximum mast Ø	mm	42	
Dimensions (L x W)	cm	99x36	
Quantity	pcs	20	
Unit weight	Kg	0.5	
Total weight	Kg	13	
Accessories			
Mast Ø	mm	42	60
Horizontal polarisation		Included	PVZ-60
Horizontal polarisation with tilt adj.			PVZ-60
Vertical polarisation		Included	PVZ-60
Vertical polarisation with tilt adj.			PVZ-60
Auxiliary boom			N/A

Gain (x: frequency MHz, y: gain ISO dBi) and **Pattern** (UHF @862MHz)

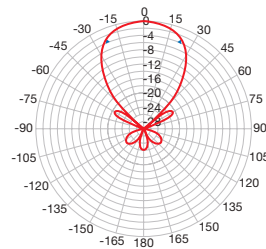
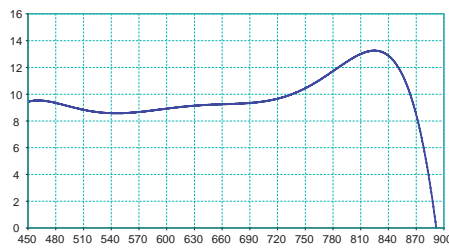

10RD45F



Aerials

UHF aerials

Panel aerials

Panel aerials with high gain, steel reflector, F connector and aluminium radiant elements for PU4F and P54F and steel for PU4AF.



PU4F



PU4AF

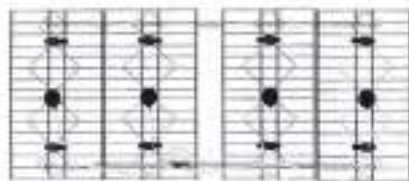

PU16F

Item		PU4F	PU4AF	PU8F	PU16F
Code		217424	217423	217428	217436
Elements	No.	UHF	UHF	UHF	UHF
Channels		E21-E69	E21-E69	E21-E69	E21-E69
Bandwidth	MHz	470-862	470-862	470-862	470-862
Maximum gain	dBi	12	14	16	18,5
Front-to-back ratio	dB	21	20	26	28
Return loss	dB	-14	-14	-10	-10
Beamwidth (-3dB)	°	±30	±24	±15	±10
Wind load at 120Km/h (720N/m2)	Kg (N)	4.0 (39.24)	5.0 (49.5)	13 (127.53)	26 (255.06)
Connector	type				F
Impedance	Ohm				75
Maximum mast Ø	mm				60
Dimensions (L x W)	cm	71x38.5	50x76.5	88.5x72	167x72
Quantity	pcs	15	10	1	1
Unit weight	Kg	0.94	1.3	2.9	5.28
Total weight	Kg	14.8	13.3	2.9	5.28
Accessories					
Horizontal polarisation					included
Horizontal polarisation with tilt adj.					N/A
Vertical polarisation					N/A
Vertical polarisation with tilt adj.					N/A
Auxiliary boom					N/A

Gain (x: frequency MHz, y: gain ISO dBi) and Pattern (@862MHz)

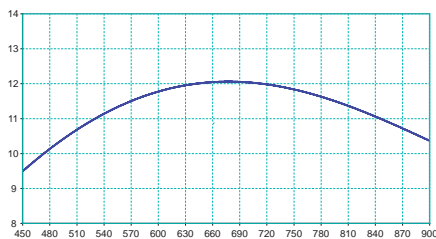

PU4F

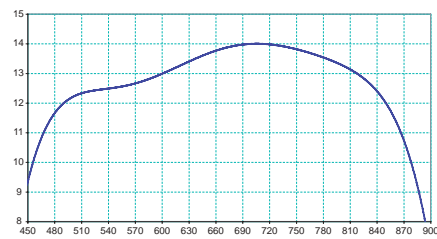
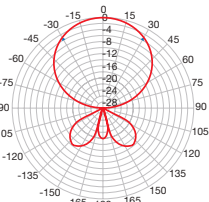

PU4AF

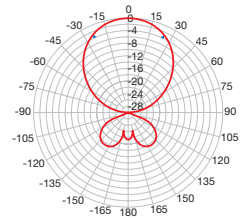

Gain (x: frequency MHz, y: gain ISO dBi) and Pattern (V @862MHz)

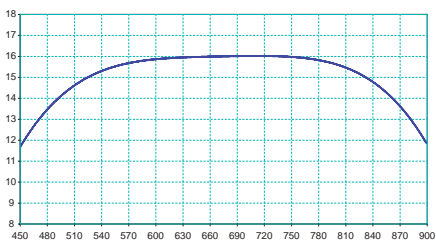

PU8F

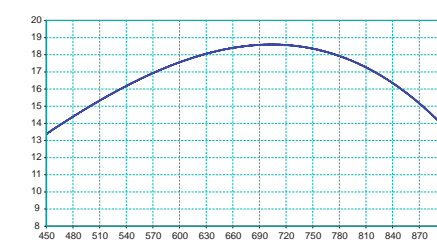
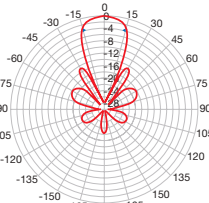

PU16F

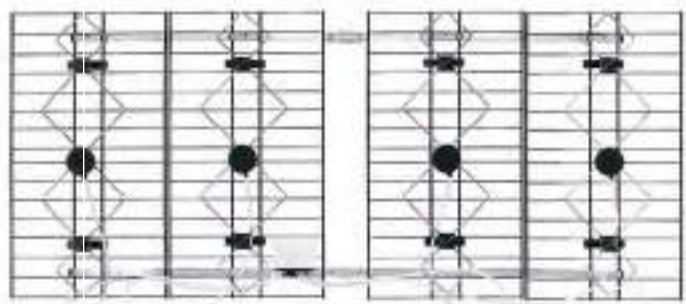
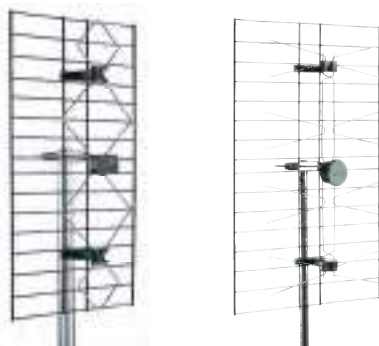
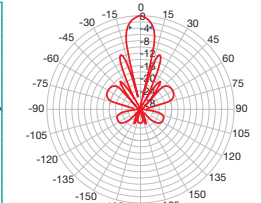

UHF+VHF aerials

Combined aerials

Wideband aerials with F connector. The technology applied to these aerials allows the reception of both VHF and UHF bands with a unique aerial, guaranteeing the same performances of two separate aerials. Can be installed quickly and easily without any other tools.



SIGMA COMBO LTE



BLU COMBO LTE

Item	SIGMA COMBO LTE		BLU COMBO LTE		
	213223		217911		
Code	213223		217911		
Elements	No.	2	6	4	8
Band		III	UHF	III	UHF
Channels		E5-E12	E21-E60	E5-E12	E21-E60
Bandwidth	MHz	174-230	470-790	174-230	470-790
Maximum gain	dBi	9	14	7	12
Front-to-back ratio	dB	20	32	20	32
Return loss	dB	-14	-18	-14	-18
Beamwidth (-3dB)	°	±25	±20	±25	±20
Wind load at 120Km/h (720N/m ²)	Kg (N)	26 (256)		26 (256)	
Connector	type	F		F	
Impedance	Ohm	75		75	
Maximum mast Ø	mm	60		60	
Dimensions (L x W)	cm	108 x 100		118 x 100	
Quantity	pcs	6		8	
Unit weight	Kg	3.83		2.76	
Total weight	Kg	27		26	
Accessories					
Horizontal polarisation		included		included	
Horizontal polarisation with tilt adj.		included		included	
Vertical polarisation		included		included	
Vertical polarisation with tilt adj.		included		included	
Auxiliary boom		N/A		N/A	

Gain (x: frequency MHz, y: gain ISO dBi) and **Pattern** (@200MHz)

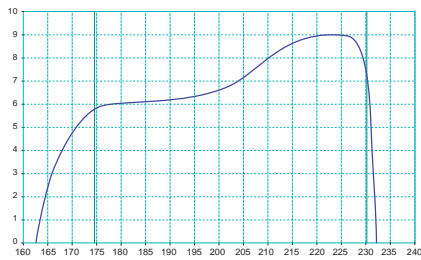

SIGMA COMBO LTE - VHF

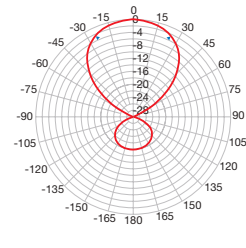

Gain (x: frequency MHz, y: gain ISO dBi) and **Pattern** (@790MHz)

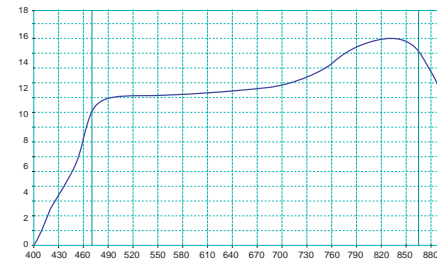

SIGMA COMBO LTE - UHF

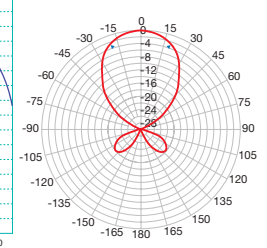

Gain (x: frequency MHz, y: gain ISO dBi) and **Pattern** (@200MHz)

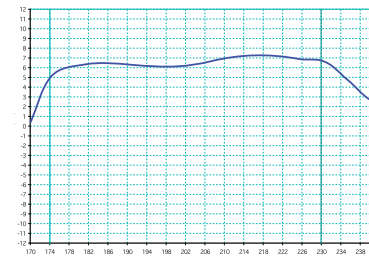

BLU COMBO LTE - VHF

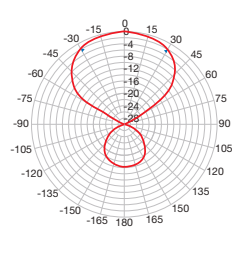

Gain (x: frequency MHz, y: gain ISO dBi) and **Pattern** (@790MHz)

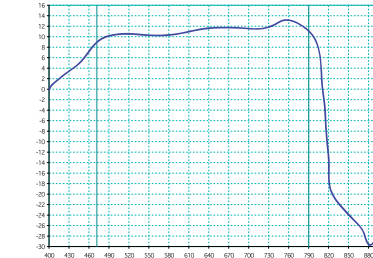

BLU COMBO LTE - UHF

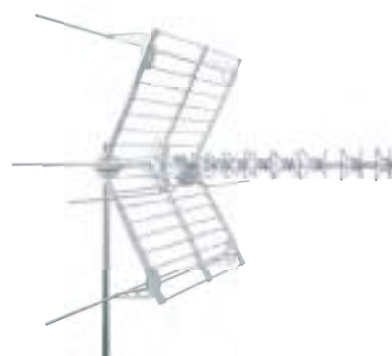
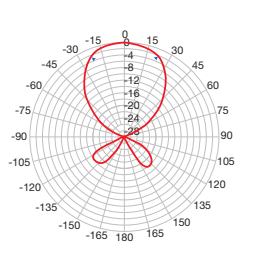

Aerials

LOG-PERIODIC aerials

LP series with F connector

Log-periodic pre-assembled aerials characterised by: easy connection due to the connector being located near the mast clamp. High level design of the dipole connection guarantees a highly reliable RF contact. Due to the specific mast clamp these aerials can be assembled in vertical or horizontal polarisation without additional accessories. They have excellent mechanical clamp resistance of the boom elements, great mechanical resistance at the rotation around the mast and good electrical performances. F connector is protected by a cap with bayonet clamp.



Item		LP345F	LP345MF	LPV345F
Code		216170	216169	217350
Band	No.	III+UHF	III+UHF	III+UHF
Channels		E5-E12/E21-E69	E5-E12/E21-E69	E5-E12 / E21-E69
Bandwidth	MHz	174-230/470-862	174-230/470-862	174-230 / 470-862
Maximum gain	dBi	9.5 / 11	8.5 / 9.5	9 / 11.5
Front-to-back ratio	dB	24 / 32	22 / 30	24 / 32
Return loss	dB	-16 / -16	-14 / -13	-18 / -13
Beamwidth (-3dB)	°	±34 ±31	±34 ±30	±23 ±21
Wind load at 120Km/h (720N/m ²)	Kg (N)	3.9 (38.25)	2.7 (26.48)	2.8 (27.46)
Connector	type		F	
Impedance	Ohm		75	
Maximum mast Ø	mm		60	
Dimensions (L x W)	cm	115x86	77x86	75x79
Quantity	pcs	20	20	20
Unit weight	Kg	1.12	0.9	0.85
Total weight	Kg	22.9	18.5	17.5
Accessories				
Horizontal polarisation			included	
Horizontal polarisation with tilt adj.			PV10	
Vertical polarisation			included	
Vertical polarisation with tilt adj.			PV10	
Auxiliary boom			N/A	

Gain (x: frequency MHz, y: gain ISO dBi) and Pattern (@200/862MHz)

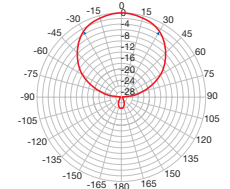
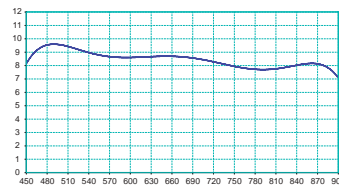
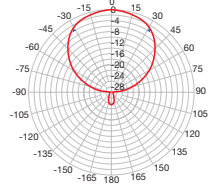
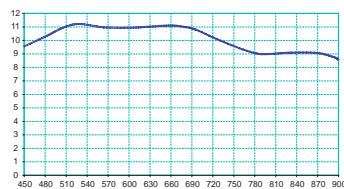
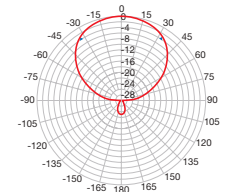
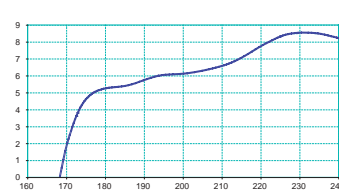
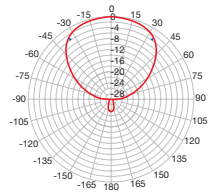
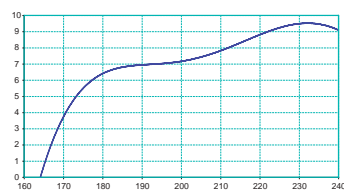

LP345F

LP345MF

Gain (x: frequency MHz, y: gain ISO dBi) and Pattern (@200/862MHz)

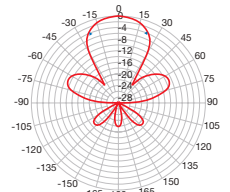
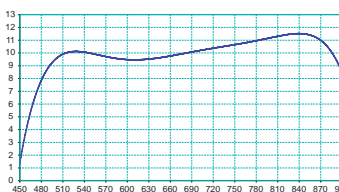
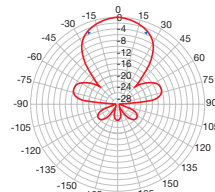
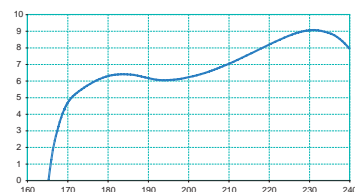

LPV345F

LOG-PERIODIC aerials

LP series with F connector

Log-periodic pre-assembled aerials characterised by: easy connection due to the connector being located near the mast clamp. High level design of the dipole connection guarantees a highly reliable RF contact. Due to the specific mast clamp these aerials can be assembled in vertical or horizontal polarisation without additional accessories. They have excellent mechanical clamp resistance of the boom elements, great mechanical resistance at the rotation around the mast and good electrical performances. F connector is protected by a cap with bayonet clamp.



LP45NF



LP45MINI

Item	LP45NF	LP45MINI	LP45F	LP34F
Code	216150	216150	216149	216135
Elements	No.	UHF	UHF	III+IV
Channels	E21-E69	E21-E69	E21-E69	E5-E12
Bandwidth	MHz	470-862	470-862	470-862
Maximum gain	dBi	11.5	8	11
Front-to-back ratio	dB	36	30	36
Return loss	dB	-15	-15	-15
Beamwidth (-3dB)	°	±25	±25	±30 ±28
Wind load at 120Km/h (720N/m2)	Kg (N)	3.0 (29.43)	2.8 (29.43)	3.0 (29.43)
Connector	type	F		
Impedance	Ohm	75		
Maximum mast Ø	mm	60		
Dimensions (L x W)	cm	115x86	99X32	115x86
Quantity	pcs	20	20	20
Unit weight	Kg	0,80	0,80	1,125
Total weight	Kg	16	16	23
Accessories				
Horizontal polarisation		included		
Horizontal polarisation with tilt adj.		PV10		
Vertical polarisation		included		
Vertical polarisation with tilt adj.		PV10		
Auxiliary boom		N/A		

Gain (x: frequency MHz, y: gain ISO dBi) and **Pattern** (@862MHz)

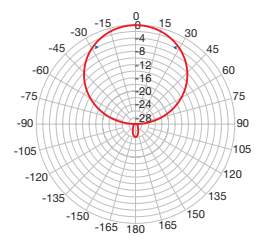
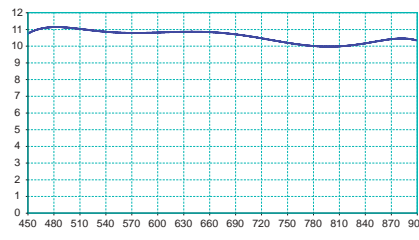
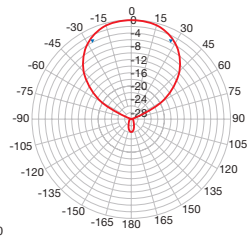
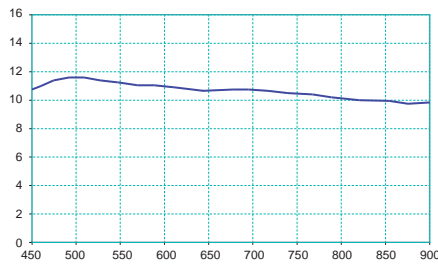

LP45NF

LP45MINI

Gain (x: frequency MHz, y: gain ISO dBi) and **Pattern** (@200/600/862MHz)

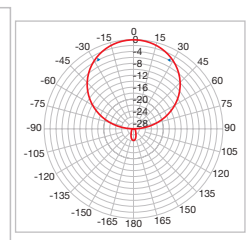
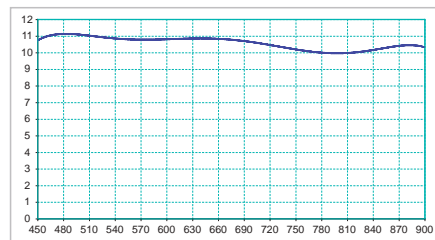
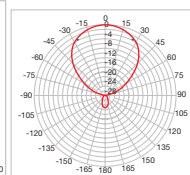
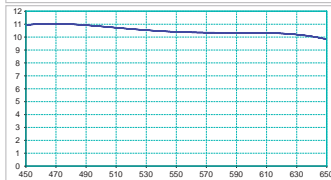
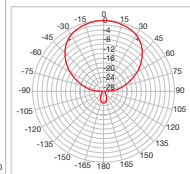
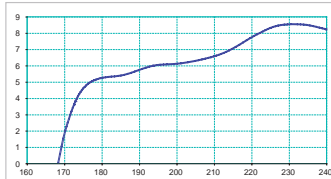

LP34F

LP45F

Aerials

LOG-PERIODIC aerials

LP series with F connector

Log-periodic pre-assembled aerial
 Easy connection
 Highly reliable RF contact
 Vertical or horizontal polarisation without additional accessories (specific mast clamp)
 Excellent mechanical clamp resistance
 F connector protected by a cap



LP3F



LP4F

Item		LP3F	LP4F	LP5F
Code		216171	216151	216108
Band		III	IV	V
Channels		E5-E12	E21-E37	E38-E69
Bandwidth	MHz	174-230	470-606	606-862
Maximum gain	dBi	10	10	12
Front-to-back ratio	dB	32	32	36
Return loss	dB	-18	-18	-15
Beamwidth (-3dB)	°	±30	±30	±25
Wind load at 120Km/h (720N/m ²)	Kg (N)	2.8 (27.46)	2.8 (27.46)	3.0 (29.43)
Connector	type		F	
Impedance	Ohm		75	
Maximum mast Ø	mm		60	
Dimensions (L x W)	cm	65x33	99x32	99x24
Quantity	pcs	60	20	20
Unit weight	Kg	0.56	0.792	0.767
Total weight	Kg	38	16.34	15.84
Accessories				
Horizontal polarisation			included	
Horizontal polarisation with tilt adj.			PV10	
Vertical polarisation			included	
Vertical polarisation with tilt adj.			PV10	
Auxiliary boom			N/A	

Gain (x: frequency MHz, y: gain ISO dBi) and Pattern (@200MHz)

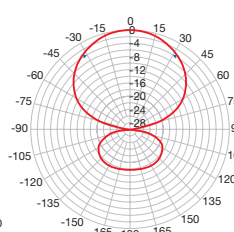
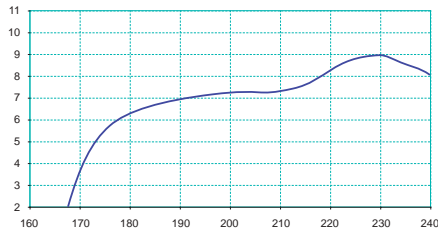

LP3F

Gain (x: frequency MHz, y: gain ISO dBi) and Pattern (@600MHz)

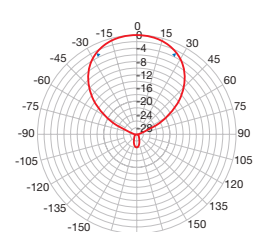
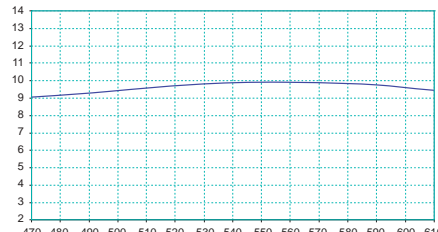

LP4F

Gain (x: frequency MHz, y: gain ISO dBi) and Pattern (@860MHz)

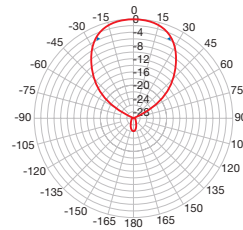
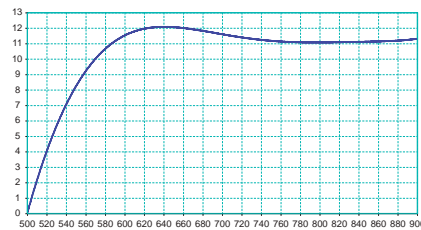

LP5F

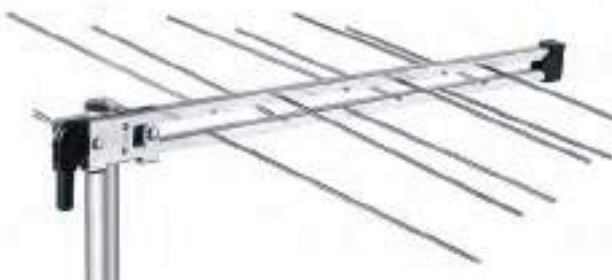

LOG-PERIODIC aerials

LP series

Pre-assembled aerials that are easy to install and characterised by a highly reliable RF connection. They are available in various models in order to fulfil most installations.

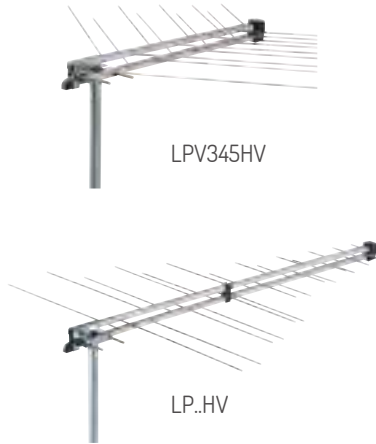

Item		LP345HV	LPV345HV
Code		216168	217349
Band		III+UHF	III+UHF
Channels		E5-E12 / E21-E69	E5-E12 / E21-E69
Bandwidth	MHz	174-230 / 470-862	174-230 / 470-862
Maximum gain	dBi	09 / 11	9 / 11.5
Front-to-back ratio	dB	24 / 32	24 / 32
Return loss	dB	-13 / -13	±23 ±21
Beamwidth (-3dB)	°	±34 ±31	±23 ±21
Wind load at 120Km/h (720N/m ²)	Kg (N)	3.9(38.25)	3.9(38.25)
Impedance	Ohm	75	75
Maximum mast Ø	mm	60	60
Dimensions (L x W)	cm	111x86	111x86
Quantity	pcs	20	20
Unit weight	Kg	1.04	0.8
Total weight	Kg	21.3	16.5
Accessories			
Horizontal polarisation			included
Horizontal polarisation with tilt adj.			PV10
Vertical polarisation			included
Vertical polarisation with tilt adj.			PV10
Auxiliary boom			N/A

Gain (x: frequency MHz, y: gain ISO dBi) and **Pattern** (@200/862MHz)

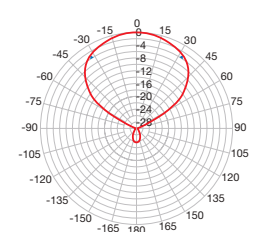
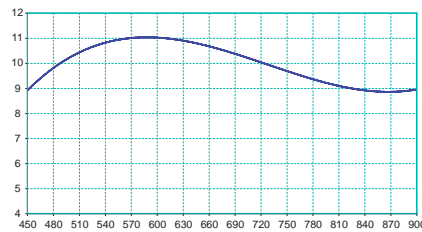
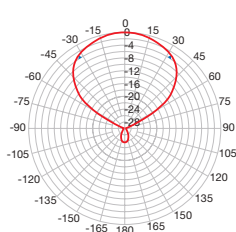
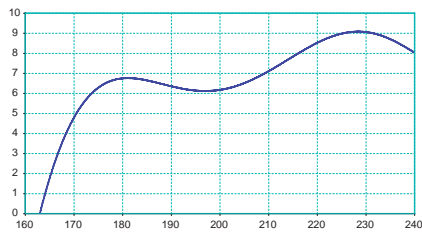

LP345HV Band III

LP345HV Band UHF

Gain (x: frequency MHz, y: gain ISO dBi) and **Pattern** (@862MHz)

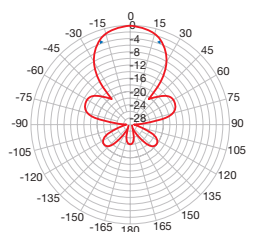
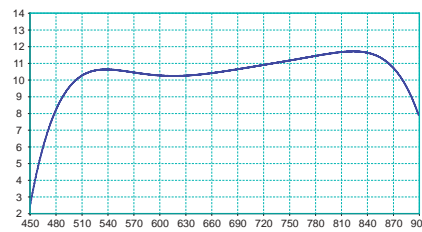
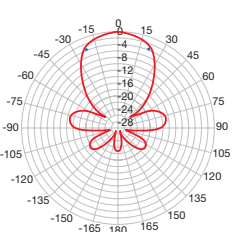
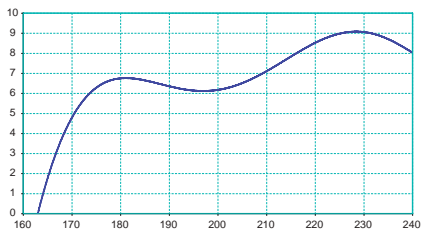

LPV345HV Band III

LPV345HV Band UHF

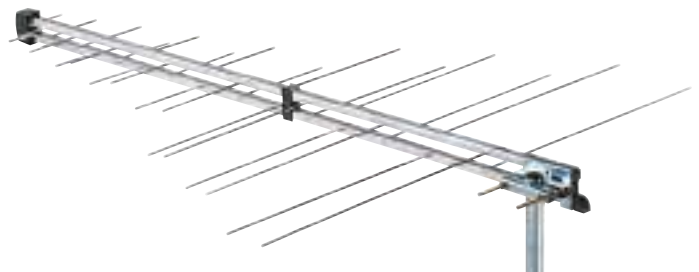
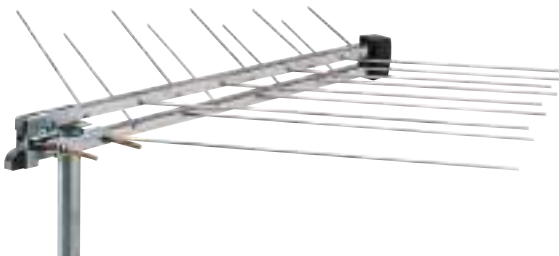

Aerials

MASTS



TEL..



PaloSB..



PaloCB..



Palcurva..

Item	code	Description	Pcs
Telescopic masts with cap			
TEL1,5/4	287243	mt 2+2=4, Ø 25+30 mm, thickness 1,5 mm, 2 nuts M8	5
TEL2/4	287241	mt 2+2=4, Ø 28+35 mm, thickness 2 mm, 4 nuts M8	3
TEL2/6	287242	mt 2x3=6, Ø 28+35+42 mm, thickness 2 mm, 4 nuts M8	2
Masts without nuts with cap			
PaloSB2 1,5/25	287244	mt 2, Ø 25x1,5mm	10
PaloSB2 2/28	287245	mt 2, Ø 28x2mm	5
PaloSB3 2/28	287246	mt 3, Ø 28x2mm	5
Masts with nuts with cap			
PaloCB2 1,5/30	287247	mt 2 Ø 30x1,5 mm, 2 nuts M8	5
PaloCB2 1,5/35	287248	mt 2 Ø 35x1,5 mm, 2 nuts M8	5
PaloCB2 1,5/40	287249	mt 2 Ø 40x1,5 mm, 2 nuts M8	5
PaloCB2 2/35	287250	mt 2 Ø 35x2 mm, 4 nuts M8	5
PaloCB2 2/42	287251	mt 2 Ø 42x2 mm, 4 nuts M8	5
PaloCB2 2/50	287252	mt 2 Ø 50x2 mm, 4 nuts M8	3
PaloCB3 2/35	287253	mt 3 Ø 35x2 mm, 4 nuts M8	3
PaloCB3 2/42	287254	mt 3 Ø 42x2 mm, 4 nuts M8	3
PaloCB3 2/50	287255	mt 3 Ø 50x2 mm, 4 nuts M8	2
PaloCB2 3/60	287256	mt 2 Ø 60x3 mm, 4 nuts M8	2
PaloCB3 3/60	287257	mt 3 Ø 60x3 mm, 4 nuts M8	1
Elbow shaped masts			
Pal curva40+att	287258	Elbow shaped mast 2 mt, fixing clips 5 cm distance. Diam. Ø 40x2mm. Elbow dismountable 180° Ø 48x2 mm	1
Pal curva50+att	287259	Elbow shaped mast 2 mt, fixing clips 5 cm distance. Diam. Ø 50x2mm. Elbow dismountable 180° from Ø 60x2 to Ø 50x2 mm	1

MASTS BRACKETS



ZN RING



ZN ESP..



ZN3PREG



ZNPM..



ZN RINF..

Item	code	Description	Pcs
Railing mast			
ZN RING	287271	Mast bracket for railing mast with nuts, Ø 30÷50 mm. Electrolytic zinc coating.	70
Adjustable brackets			
ZNESPTU10	287260	Tube 10 cm, mast Ø 25÷50 mm. Electrolytic zinc coating.	50
ZNESPTU15	287261	Tube 15 cm, mast Ø 25÷50 mm. Electrolytic zinc coating.	50
ZNESPTU20	287262	Tube 20 cm, mast Ø 25÷50 mm. Electrolytic zinc coating.	50
ZNESPT010	287268	Reinforcing rod 10 cm. Electrolytic zinc coating.	50
ZNESPT015	287269	Reinforcing rod 15 cm. Electrolytic zinc coating.	50
ZNESPT020	287270	Reinforcing rod 20 cm. Electrolytic zinc coating.	30
Tripod			
ZN3PREG	287272	Tripod mast mount, adjustable 26÷46. Hot-dipped zinc coating.	12
Wall brackets			
ZNPMEMILIA	287273	Mast Ø 40÷90 mm. Hot-dipped zinc coating.	12
ZNPMECONO	287274	Cheap bracket, mast Ø 25÷60 mm. Hot-dipped zinc coating.	40
Reinforced			
ZNRINF	287275	Mast Ø 30÷60 mm. Hot-dipped zinc coating.	15
ZNRINF5	287276	5 cm dist. for mast Ø 30÷60 mm. Hot-dipped zinc coating.	12
ZNRINF10	287277	10 cm dist. for mast Ø 30÷60 mm. Hot-dipped zinc coating.	12
ZNRINF20	287278	20 cm dist. for mast Ø 30÷60 mm. Hot-dipped zinc coating.	10

Aerials



ZNECONO..



CAV8UNIVERSAL



ZNSOLAI



ZNFRCAM..



ZNMURO



ZNCAMINO

Cheap brackets

ZNECON05	287333	Dist. 5, for mast Ø 30÷60 mm. Hot-dipped zinc coating.	25
ZNECON010	287279	Dist. 10, for mast Ø 30÷60 mm. Hot-dipped zinc coating.	25
ZNTELE20	287332	Adjustable 20 - 33cm. Hot-dipped zinc coating.	25

Clevis

CAV8DIST	287280	"8" clevis with distance 60mm, for mast Ø 30÷60 mm. Hot-dipped zinc coating.	15
CAV8UNIVERSAL	287281	Universal "8" clevis for mast Ø 30÷60 mm. Electrolytic zinc coating.	25
CAV8	287282	"8" clevis for Ø 25mm. Electrolytic zinc coating.	60

Plate

ZNSOLAI	287283	Ø 30÷50 mm. Hot-dipped zinc coating.	20
---------	--------	--------------------------------------	----

Chimney brackets (French style)

ZNFRCAMNEW28	287285	28 cm, Ø 25÷50mm. Hot-dipped zinc coating.	20
ZNFRCAM32	287284	32 cm, Ø 25÷50mm. Hot-dipped zinc coating.	12

Reinforced

ZNMURO	287288	Reinforced wall mount 30cm. Electrolytic zinc coating.	25
--------	--------	--	----

Chimney

ZNCAMINO	287287	Chimney mount dist. 14 cm, Ø 25÷45mm. Electrolytic zinc coating.	30
----------	--------	--	----

Mechanical accessories

RALLATRIS	287289	Belt 20x3, for Ø 25÷45 mm. Electrolytic zinc coating.	100
TENDIFILO	287290	Tension disks M90, for wire Ø 5mm max. Electrolytic zinc coating.	100
CONTROPIASTRA	287291	Guard plate for ZN PM EMILIA. Hot-dipped zinc coating.	1
NASTROZNF	287263	Zinc belt for french brackets 40x0,5mm,25mt. Electrolytic zinc coating.	5
TEGOLAPVC	287292	PVC tile for max Ø 60mm	30
TEGOLAPIOMBO	287293	Lead tile for max Ø 60mm	5
CAPPUCCIOPVC	287294	PVC cap for Ø 40÷80 mm	200
SUPUNIVERSAL	287264	Universal dish bracket Ø 40x1,4mm. Hot-dipped zinc coating.	15
SUPMUR026	287265	Wall bracket dist. 26 cm Ø 40x1,4mm. Hot-dipped zinc coating.	20
SUPMUR046	287266	Wall bracket dist. 46 cm Ø 40x1,4mm. Hot-dipped zinc coating.	10
SUPCURV0180G	287267	Elbow shaped bracket Ø 30x60mm. Tube Ø 40x1,4mm. Hot-dipped zinc coating.	8
PVP	210002	For panel aerial with vertical polarisation	20
PV10	210011	For panel aerial with vertical polarisation	30
CA2	219602	Auxiliary booms	6
BA914	280674	Base for dish mount	1
STM1	281801	Wall bracket 40mm x 1.2m galvanized steel	1
ZPL-R650	287179	Guyed extendable mast	10
ZPL-R450	287180	Base for telescopic masts	12
AN1	293108	Angolare salvaspighi con bugne per contenere il filo di ferro di fissaggio delle zanche	2
BA6	293400	Base for telescopic masts	20

Aerials

SAT dishes

PENTA series

Dual feed support
White, grey and brick red colours



Item		PENTA DIGIT	PENTA85
Frequency range	GHz	10.7-12.75	10.7-12.75
Dimensions Ø	mm	624x624	775x775
Offset angle	°	22.3	22.1
Efficiency		≥70%	≥70%
Gain at 10.95GHz	dB	36.5	39
Cross polarisation on axis	dB	>37	>38
First side lobe	dB	<-32	<-34
Noise temperature		40°K at 30° elevat.	40°K at 30° elevat.
F/D ratio		0.7	0.7
Beamwidth [-3dB]	°	3	2.2
LNB clamp	mm	23-28; 40; 60	23-28; 40; 60
Elevation angle		Maximum tilt 60°	Maximum tilt 60°
Mast clamp	mm	35-80	35-80
Material		Alumium/steel	Alumium/steel
Bracket material		Steel - aluminium zinc treatment	Steel - aluminium zinc treatment
Wind load at 150Km/h	Kg	53	81

Individual packaging

Equivalent Ø cm	Model	Item	Code	Material	Colours	Dual feed support 6°	Mounting kit
68	DIGIT	DIGIT-A	211104	Steel	white	DFPDIGIT 211003	included
		DIGIT-GA	211105		grey		
		DIGIT-RA	211106		brick red		
		DIGIT	211101	Aluminium	white		
		DIGIT-G	211102		grey		
		DIGIT-R	211103		brick red		
85	PENTA	PENTA85-A	211205	Steel	white	DFP85R 211002 (Adjustable rotation)	
		PENTA85G-A	211206		grey		
		PENTA85R-A	211207		brick red		
		PENTA85	211201	Aluminium	white		
		PENTA85G	211203		grey		
		PENTA85R	211204		brick red		

Multiple packaging - 10 pcs

Equivalent Ø cm	Model	Item	Code	Material	Colours	Dual feed support 6°	Mounting kit
68	DIGIT	DGTX10-A	211112	Steel	white	DFPDIGIT 211003	ZNC DGTX10 211110
		DGTX10-GA	211116		grey		
		DGTX10	211111	Aluminium	white		
85	PENTA	P85X10-A	211210	Steel	white	DFP85R 211002 (Adjustable rotation)	ZNC85X10 211208
		P85G10-A	211217		grey		
		P85R10-A	211216		brick red		
		P85X10	211209	Aluminium	white		
		P85G10-B	211212		grey		
		P85R10-B	211211		brick red		

SAT dishes
OFFSETseries 60-85 cm

R080SC



R080AP



R060AP

Item		R060AP	R060A	R080AP	R080SC	R085AP
Dimension	mm	630x590	632x583	768x846	810x750	910x837
Offset angle	°	23	24	23	22.75	21
F/D ratio		0.65	0.66	0.66	0.66	0.66
Elevation angle	°	20/55	4/55	0/60	0/50	1/60
Mast clamp	mm	25-50	20-50	30-60	30-60	30-60
Efficiency	%	>70	>69	>75	>75	>70
Gain at 10.7 GHz	dB	34.4	34.7	37.0	37.6	37.4
Gain at 11.7 GHz	dB	35.0	35.5	37.7	38.2	38.2
Gain at 12.7 GHz	dB	36.4	36.2	38.5	38,6	38.9

Single packaging

Equivalent Ø cm	Item	Code	Material	Colours	Dual feed support 6°	Mounting kit
80	P80APN R080AS dish	211316	Steel	white	DFAN cod. 289487	included

Multiple packaging

Equivalent Ø cm	Item	Code	Material	Colours	Dual feed support 6°	Mounting kit	Packaging
60	P060APX5 R060AP dish	287185	Steel	white	-	included (ZN060AP)	5
	R060AX10 R060A dish	280610	Steel	White	-	ZN060AC cod. 289279	10
	R060APX400 R060AP dish	287186	Steel	white	-	ZN060AP cod. 287187	400
80	R080APX50 R080AP dish	289479	Steel	White	DFAN cod. 289487	ZN080APN steel - cod. 289480	50
	R080APX200 R080AP dish	289283	Steel	White	DFAN chi cod. 289487	ZN080APN steel - cod. 289480	200
	P080SCX50 R080SC dish	287402	Steel	Light grey	-	included (Z080SC)	50
85	R085APX5G R085AP dish	289828	Aluminium	Grey	DF0100C cod. 289294	ZN085PX5G cod. 289829	5



R060AP + ZN060AP



R080AP + ZN080APN



R080AS + ZN080ACN

Aerials

SAT dishes

OFFSETseries 100-150 cm



Item		R0100C	R0100AC	R0100AP	R0120N	R0125AP	R0150
Dimension	mm	970x1040	970x1040	1032x952	1164x1240	1345x1240	1614x1488
Offset angle	°	21	21	23	23	23	21.3
F/D ratio		0.66	0.66	0.66	0.66	0.66	0.66
Elevation angle	°	0/80	0/80	0/90	20/50	0/90	20/90
Mast clamp	mm	30-90	30-90	35-60	55-100	40-60	55-100
Efficiency	%	>70	>70	>72	>70	>74	>70
Gain at 10.7 GHz	dB	39.7	39.7	39.4	40.5	41.0	42.6
Gain at 11.7 GHz	dB	40.2	40.2	40.0	41.4	41.6	43.4
Gain at 12.7 GHz	dB	40.5	40.5	40.6	42.3	42.4	44.2

Single packaging

Equivalent Ø cm	Item	Code	Material	Colours	Dual feed support 6°	Mounting kit
100	PT100C R0100C dish	289291	Aluminium	Light grey	DF0100C cod. 289294	included (ZN0100C)
	PT100AC R0100AC dish	289293	Steel	White	DF0100C cod. 289294	included (ZN0100C)
120	R0120N R0120N dish	289197	Aluminium	White	DF0120N cod. 289199	AZ0120N cod. 289196 AZ0120-PP cod. 289949
150	R0150 R0150 dish	289139	Aluminium	White	DF0120N cod. 289199	AZ0150 cod. 289140

Multiple packaging

Equivalent Ø cm	Item	Code	Material	Colours	Dual feed support 6°	Mounting kit	Packaging
100	R0100ACX6 R0100AC dish	289299	Steel	white	DF0100C cod. 289294	ZN0100C cod. 289285	6
	R0100APX5G R0100AP dish	289830	Aluminium	Grey	DFAN cod. 289487	ZN0100PX5 cod. 289831	5
125	R0125APX3G R0125AP dish	289832	Aluminium	Grey	-	ZN0125PX3 cod. 289833	3

Wind load refers to the diameter of the reflector with 120Km/h wind speed (Kg)

Equivalent Ø dish cm	60	65	75	80	85	90	100	120	150
Wind load @ 120Km/h Kg	34	42	47	55.2	70	80	91	145	235

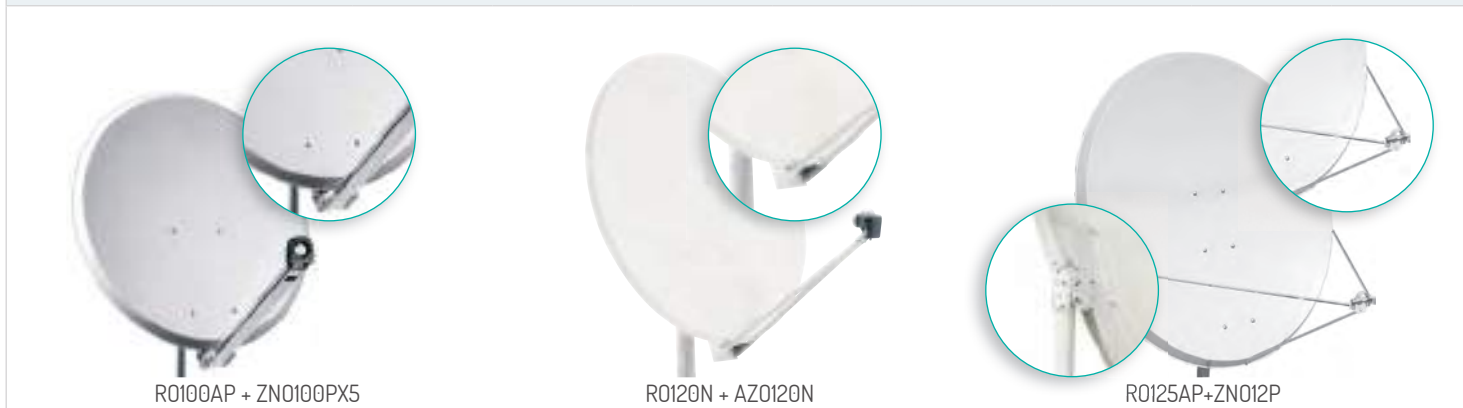

LNB's

Universal LNB's

Excellent signal quality
Maximum quality reception of all High Definition (HD) programs.



UX-S LTE



UX-QT LTE

Item	Code	Description	Outputs	Gain dB	Power cons. mA	LTE shielding
Universal						
UX-S LTE	287337	Single, LTE filtered Sky IT approved	1	60	70	52
UX-TW LTE	287338	Twin, LTE filtered	2	60	150	53
UX-QD LTE	287339	Quad, LTE filtered Sky IT approved	4	60	160	45
UX-OCTO LTE	287340	Octo, LTE filtered	8	60	190	52
UX-QT LTE	287302	Quattro, LTE filtered Sky IT approved	4 (VL, VH, HL, HH)	57	160	60
Universal Monobloc						
UX-MBS6	287139	Monobloc 6°, Single	1	55	110	-
UX-MBTW6	287140	Monobloc 6°, Twin	2	55	190	-
UX-MBQD6	287141	Monobloc 6°, Quad	4	55	190	-

LNB's

SCR LNB's

Allows up to 4 decoders to be connected
4 outlets work constantly
Low phase noise and consumption
4 SCR outputs + 1 legacy (universal) output
High frequency stability
Sky approved, LTE shielded



SCR41S

Item	SCR41S
Code	287218
Users SCR	No. 4
Users Legacy	No. 1
Input frequency	GHz 10.7 to 11.7 - 11.7 to 12.75
Gain	dB 50-65
Consumption	mA 350 max.
Output frequency SCR	MHz 1210 - 1420 - 1680 - 2040
Output frequency Legacy	MHz 950-2150
Band and polarity selection SCR	DiSeqC-ST command
Band and polarity selection Legacy	Vertical 11.5 to 14 V, Horizontal 16 to 19V Low Band 0KHz - High Band 22KHz±4KHz

Installation example SCR LNB's

SCR LNBs allow up to 4 satellite receivers to be connected to the same dish by using a single cable. SCR LNBs have a double output:

- "Legacy" behaves like a universal one output LNB,
- "Unicable" connects the cable to the 4 satellite receivers.

By simultaneously using the 2 outputs, it is possible to connect up to 5 satellite receivers.

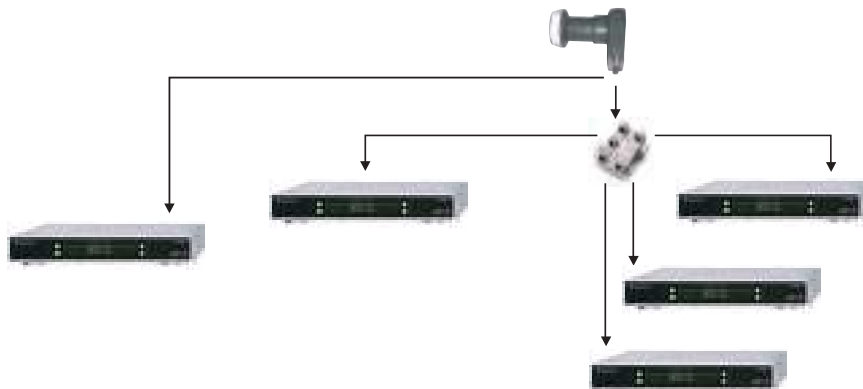

Aerials

KIT SAT

Kit Sat



Item	Code	Description
P80APK	211308	Composed by R080AS, ZN080ACN and UX-S LTE
P85AK	211220	Composed by PENTA85-A and UX-S LTE
SAT21601	211311	Composed by R060AP, ZN060AP and UX-S LTE
Kit 9/13 R080	211319	Composed by R080, ZN080, DFP 9-13 and MB3UZ

DiSEqC switches

DSQ series

Line switches with DiSEqC control on coaxial cable, controlled by satellite receivers with built-in DiSEqC tone generator.



DSQ21J

DSQ41J

Item		DSQ21J	DSQ41J
Code		289588	289589
Band	Hz	950-2300	950-2300
Inputs	No.	2	4
Outputs	No.	1	1
Insertion loss	dB	4	4
DiSEqC		2.0	2.0
Isolation	dB	35	35
Packaging	pcs	1	1

Line amplifier

AS series

Line switches with DiSEqC control on coaxial cable, controlled by satellite receivers with built-in DiSEqC tone generator.



AS20

Item		AS20
Code		284013
Band	Hz	950-2150
Gain	dB	12-17
Noise	dB	8
Operational voltage	V	13-18
Consumption	mA	40@13V
Impedance	Ohm	75
Connectors	Type	F female
Output dBμV	dBμV	105
Packaging	Pcs	1
Dimensions	mm	1x1,5x70

Dual feed support



DFAN

Item	code	Description	Pcs
DFAN	289487	Dual feed support 6° for: P80APN, R080AP and R080AS dishes	1
DF0100C	289294	Dual feed support 6° for: R085AP, PT100C and PT100AC dishes	1
DF0120N	289199	Dual feed support 6° for: R0120N and R0150 dishes	1

Electronic mast and indoor equipment	
LTE filters	48
Combiners Attenuators	
MX series	48
ESV.. series	49
Indoor combiners with F connectors	
JSVU3	49
TV-SAT Mixers	
MXST	49
PAS0303011	49
Mast amplifiers	
ES.. Series	50
JS2RT	50
MAP 12 Volt Series	51
MAP 24 Volt Series	52
MAK series	52
Line amplifiers	50
Kit LTE	53
Power supplies	
AM.. Series	53
Power supplies Series – Switching mode	53
Indoor amplifiers	
AFI series	54
MINIBOOST	54
MOD HD-TV series	55
MOD90 series	56
MOD90S	56
Mast channel processor	57
Multiband amplifiers	
MBJ series	58
MBX series	59
Headend amplifiers	60
Programmable equaliser filters	61
Programmable headends	62

Mast and indoor electronic equipment

LTE Filters



LTE FILTER
Dimensions 70x20x20mm



4GKILLER
Dimensions 74x36x58mm

LTE filters

Indoor and outdoor LTE filters to avoid any eventual interference due to LTE (4G) signals.

- High selectivity up to 30dB@793 MHz
- Low insertion loss

Item	Code	Input 1	Input 2	Insertion loss dB Input 1	Note	IP protection	Selectivity
4GKILLER	226710	VHF+UHF	470-790	1	A - CEI100-7	-	30dB@793MHz
LTE FILTER 60	226709	VHF+UHF	470-790	1.5	Waterproof	IP66	30dB@801MHz
LTE FILTER 59	226711	VHF+UHF	47-782	1.5	Waterproof	IP66	30dB@791MHz
LTE FILTER 48	226715	VHF+UHF	470-694	1.5	Waterproof	IP66	30dB@704MHz
FM FILTER	226714	VHF+UHF	5-862	1.5	Waterproof	IP66	30dB (88-108MHz)

Combiners Attenuators



MX.. series
Dimensions 74x36x58mm

MX series

2 or 3 input Mast combiners with F connectors, can be used as a demixer using the output connector as an input (mix).

Operating temperature: -10 to 55°C.

- Impedance 75 Ohm
- Adjustable plastic strap for mast mounting Ø 60mm max.
- Totally shielded metal frame

Item	Code	Input 1	Input 2	Input 3	Output 1	Output 2	Insertion loss dB			Return loss dB	Mul. pack. Pcs
							Input 1	Input 2	Input 3		
MX201	223201	VHF + DC	UHF	-	Mix + DC	-	0.2	0.2	-	20	6
MX202	223202	VHF + UFC + DC	VHF + UHF (with or without DC)	-	Mix + DC	-	4	4	-	10	6
MX203	223203	VHF + DC	UHF	-	Mix + DC	Mix + DC	3.5	3.5	-	10	6
MX205	223217	VHF + UHF	Sat + DC	-	Mix + DC	-	0.5	1	-	15	6
MX206	223218	B. I + FM	B. III	UHF + DC	Mix + DC	-	0.5	0.5	1	15	6
MX210	223222	VHF	B. IV	B. V + DC	Mix + DC	-	0.5	1	1	15	6
MX210..*	223223	VHF	B.IV	B.V+DC	Mix + DC	-	0.5	1	1	15	6
MX211	223221	VHF	UHF	UHF + DC	Mix + DC	-	0.5	4	4	15	6

Combiners Attenuators



ESV..
Dimensions 74x36x58mm

ESV.. series

Mast combiners with saddle and clamp connections.

- Output connector usable as an input (mix)
- Adjustable plastic strap for mast mounting

Item	Code	Input 1	Input 2	Input 3	Output 1	Output 2	Insertion loss dB			Return loss dB	Mul. pack. Pcs
							Input 1	Input 2	Input 3		
ESV45 ⁽¹⁾	226804	VHF	IV (ch. 21-35)	V (ch. 39-69) + DC	Mix + DC	-	0.5	1	1	10	10
ESVUU	226806	VHF	UHF + DC	UHF	Mix + DC	-	0.5	4	4	10	10
ESVU	226801	VHF	UHF + DC	-	Mix + DC	-	1	1	-	10	10

⁽¹⁾ Band IV ends at 590MHz (channel 35), band V begins at 614MHz (channel E39)

Indoor combiner with F connectors

JSVU. series

Indoor combiner with F connectors.

- Totally shielded metal frame

Item	Code	Input 1	Input 2	Output 1	Insertion loss dB		Return loss dB	Mul. pack. Pcs
					Input 1	Input 2		
JSVU3	226804	VHF+S (40-446MHz)	IV (ch. 21-35) (470-862MHz)	Mix	1	1	10	20

TV-SAT Mixers



MXST
Dimensions 48x50x20mm

Indoor combiners

Also be used as a demixer.

- High isolation between inputs

Item	Code	Input 1	Input 2	Output 1	Insertion loss dB		Return loss dB	Mul. pack. Pcs
					Input 1	Input 2		
MXST	226400	TV (47-862MHz)	SAT + DC (950-2150MHz)	Mix + DC	0.5	0.5	15	15
PAS0303011	PAS0303011	TV (47-862MHz)	SAT + DC (950-2150MHz)	Mix + DC	0.5	0.5	10	15

Mast and indoor electronic equipment

Mast amplifiers



ES..
Dimensions 74x36x58mm



ES.. Series

To amplify and mix signals coming from 1 or 2 aerials.
Waterproof plastic housing. Power requirement 12VDC, on a single output.

- Adjustable plastic strap for mast mounting Ø 60mm max.
- Operating temperature: -10 to 55°C.

Item	Code	Inputs	Input band MHz	Gain dB	Output level* dBµV	Noise figure dB	Power consump. mA@12VDC	Mul. pack. Pcs
ES1/RVU	226909	2	IN1: 47-230 IN2: 470-862	4-12	115	4	27	10
ES1/Q	226905	1	174-862	12	115	4	28	10
ES2/Q	226913		174-862	22	115	4	50	10
ES2RT	226912		47-862	8-23	115	4	50	10
ES2/RU	226917		470-862	10-25	115	4	55	10

Mast amplifiers



JS2RT
Dimensions 74x35x89mm

JS2RT

To amplify signals coming from 1 aerial.
Waterproof plastic housing. Power requirement 12VDC, on a single output.

- Adjustable plastic strap for mast mounting Ø 60mm max.
- Operating temperature: -10 to 55°C.

Item	Code	Inputs	Input band MHz	Gain dB	Output level* dBµV	Noise figure dB	Power consump. mA@12VDC	Mul. pack. Pcs
JS2RT	226905	1	174-862	12	115	4	28	10

Line amplifiers



AT14LTE..
Dimensions 70x20x20mm

AT14LTE series

- TV amplifiers
- Integrated LTE filter
- IP66

Item	Code	Inputs	Input band MHz	Gain dB	Output level* dBµV	Noise figure dB	Power consump. mA@12VDC	Mul. pack. Pcs
AT14LTE59	226712	1	174-782	14	115	2	30	15
AT14LTE69	226713		174-790	17	115	2	30	15

Mast amplifiers

 MAP1.. - MAP2.. - MAP3..
 Dimensions 105x60x95mm

 MAP4.. - MAP5..
 Dimensions 105x60x120mm

MAP 12 Volt Series

MAP amplifiers to mix and amplify signals from one or more aerials.

Power requirement 12V, one mixed output.

Adjustable plastic strap for mast mounting \varnothing 60mm max.

Operating temperature: -10 to 55°C.

- Totally shielded in a metal case and "F" type connectors
- The innovative plastic housing system locks the cover in place
- The amplifier can be tilted inside to enable quick and easy installation

Item	Code	Inputs	Input band	Gain dB	Output level dB μ V	Gain adj. dB	Noise figure dB	Power consump.	Mul. pack. Pcs
MAP106⁽¹⁾	223122	1	VHF+UHF	34	115	15	5	75	10
MAP113 LTE	223513		UHF	34	115	15	5	75	10
MAP115 LTE	223523		III+DAB+UHF	30	115	15	5	75	10
MAP204LTE	223511	2	III+DAB, UHF	25,24	115	15,15	5,5		10
MAP206LTE	223520		III+DAB, UHF	35,35	115	15,15	5,5		10
MAP207LTE	223524		III+DAB+UHF, UHF	30,30	115	15,15	5,5		10
MAP208	223161		III+DAB, UHF	34, 35	108	15, 15	4, 3	80	10
MAP210/31-33⁽³⁾	223523	3	VHF+IV, V	-2, 11	115	- , -	- , 5	40	10
MAP303/31-33⁽²⁾	223128		VHF, IV, V	-2, -2, 12	115	- , - , -	- , - , 5	40	10
MAP313LTE	223511		VHF, UHF, UHF	24, 30, 30	115	15,15,15	5,8,8	75	5
MAP315LTE	223522		VHF, UHF, UHF	30, 38, 38	115	15,15,15	5,8,8	95	5
MAP401	223195		III+DAB,FM,UHF, SAT	21,19,19,-4	112	15,15,15,-	5,5,8,-	60	5
MAP413LTE**	223510		FM,III,UHF, UHF	24,24,30,30	115	15,15,15,15	5,8,8	75	10
MAP540LTE	223508	4	III+DAB, IV, V, UHF	15,10,10,10	115	- , - , - , -	4,8,8,8	40	5
MAP540LTE/..	223514		III+DAB, IV, V, UHF	15,10,10,10	115	- , - , - , -	4,8,8,8	40	5
MAP541LTE	223509		III+DAB, IV, V, UHF	24,19,20,20	115	15,15,15,15	4,8,8,8	60	5
MAP541LTE/..	223515		III+DAB, IV, V, UHF	24,19,20,20	115	15,15,15,15	4,8,8,8	60	5
MAP541LTE/40-42	223525		III+DAB, IV, V, UHF	24,19,20,20	115	15,15,15,15	4,8,8,8	60	5

⁽¹⁾ To allow the FM band to pass, cut the P1 link

⁽³⁾ Models with suffix /.. are tuned specially, the last channel of band IV and the first channel of band V must be specified on order (e.g. MAP541/31-33)

** Mast amplifier with two outputs

* In the standard models without a suffix, band IV includes channels E21-E35 and band V includes channels E36-E60

Mast and indoor electronic equipment

Mast amplifiers



MAP1.. - MAP2.. - MAP3..
Dimensions 105x60x95mm



MAP 24 Volt Series

MAP amplifiers to mix and amplify signals from one or more aerials. Power requirement 24V, one mixed output.

Adjustable plastic strap for mast mounting Ø 60mm max.

Operating temperature: -10 to 55°C.

- Totally shielded in a metal case and "F" type connectors
- The innovative plastic housing system locks the cover in place
- The amplifier can be tilted inside to enable quick and easy installation

Item	Code	Inputs	Input band	Gain dB	Output level* dBµV	Gain adj. dB	Noise figure dB	Power consump.	Mul. pack. Pcs
MAP110	223196	1	DAB + UHF	13	115	-	2.5	30	10
MAP102	223121		UHF	33	115	15	5	70	10
MAP113LTE24 (1)	223516		UHF	30	115	15	5	70	10
MAP111	223506		UHF	13	115	-	2.5	30	10
MAP116I	223507		UHF	27	115	15	2.5	60	10
MAP201LTE (1)	223512		2	VHF+UHF	24,34	115	15,15	5,5	75
MAP300LTE	223521	3	III+UHF+UHF	24,30,30	115	15,15,15	5,5,5	75	10

⁽¹⁾ To allow the FM band to pass, cut the PI link

• In the standard models without a suffix, band IV includes channels E21-E35 and band V includes channels E39-E69

Mast amplifiers



MAK..
Dimensions 127x58x129mm



MAK Series

MAK amplifiers are used to mix and amplify signals from different aerials in small and medium installations.

Power requirement 12VDC. Adjustable gain 0-20dB on each input.

Adjustable plastic strap for mast mounting Ø 60mm max.

Operating temperature: -10 to 55°C.

- Separate amplification for VHF and UHF bands
- Remote power supply selectable on each input, 100mA max.
- Totally shielded in a metal case with black plastic housing and equipped with "F" type connectors

Item	Code	Inputs	Inputs / Gain dB						Noise figure dB VHF/UHF	Output level* dBµV VHF/UHF	Power consump mA@12VDC	Pack. Pcs
			B. I	B. III	B. IV	B. V	B. UHF	B. UHF				
MAK2510LTE	223387	1	-	21	25	25	-	-	4/8	115/120	105	1
MAK2331LTE	223389	3		21	-	-	23	23	4/8	115/118	85	1
MAK2340LTE	223393	4		19	22	22	22	-	4/8	115/118	85	1
MAK2340LTE/.	223390			19	22	22	22	-	4/8	115/118	85	1
MAK2340LTE/40-42	223388			19	22	22	22	-	4/8	115/118	85	1
MAK2640LTE	223392			30	30	30	30	-	4/8	115/120	175	1
MAK2640LTE/.	223391			30	30	30	30	-	4/8	115/120	175	1

• In the standard models without a suffix, band IV includes channels E21-E35 and band V includes channels E39-E69

Kit LTE

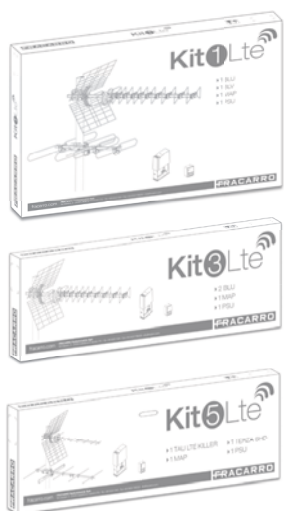

Item	Code	Description
KIT 1 LTE	217921	Composed by 1 BLU10HD LTE + 1 BLV4F + 1 MAP54LTE + 1 MINIPOWER12P
KIT 2 LTE	217922	Composed by 2 BLU10HD LTE + 1 BLV4F + 1 MBJ3640LTE
KIT 3 LTE	217923	Composed by 2 BLU10HD LTE + 1 MAP54LTE + 1 MINIPOWER12P
KIT 4 LTE	217924	Composed by 1 BLU10HD LTE + 1 MAP54LTE + 1 MINIPOWER12P
KIT 5 LTE	217925	Composed by 1 TAU KILLER LTE + 1 TERZA 6HD + 1 MAP54LTE + 1 MINIPOWER12P
KIT 6 LTE	217926	Composed by 1 BLU 5 HD LTE + 1 TERZA 6HD + 1 MAP313LTE + 1 MINIPOWER12P
KIT 7 LTE	217927	Composed by 1 BLU 10 HD LTE + 1 TERZA 6HD + 1 MAP313LTE + 1 MINIPOWER12P
KIT 8 LTE	217928	Composed by 1 SIGMA 6HD LTE + 1 BLV6F + 1 MAP206LTE + 1 MINIPOWER12P
KIT 10 LTE	217930	Composed by 1 SIGMA 6HD LTE + 1 BLV6F + 1 MAP54LTE + 1 MINIPOWER12P
KIT 11 LTE	217931	Composed by 2 SIGMA 6HD LTE + 1 MAP313LTE + 1 MINIPOWER12P
KIT 12 LTE	217932	Composed by 2 SIGMA 6HD LTE + 1 MAP54LTE + 1 MINIPOWER12P
KIT 13 LTE	217933	Composed by 1 BLU COMBO LTE + 1 MAP115LTE + 1 MINIPOWER12P

Power supplies



AM...
Dimensions 50x87x46mm

AM.. Series

The AM series is an effective answer to all power supply requirements in any aerial installation. There is a suitable model for the system to be created, both in terms of emitted current (from 50 to 100mA) and number of outputs (one or two). Class II isolation.

Terminal connectors. Operating temperature: -10 to 55°C.

- Designed to meet the strictest qualitative and safety requirements
- Equipped with accident prevention devices
- Shut down in case of short circuits

Item	Code	Input mains voltage Vac, Hz	Output mains voltage VDC	Max. output current mA	No. of outputs	Insertion loss dB	Pack. Pcs
AM50N	289112	220-230, 50-60	12	50	1	0.2	20
AM100N	289113	220-230, 50-60	12	100	1	0.2	20
AM102N	289119	220-230, 50-60	12	100	2	4	20

Power supplies



MINIPOWER24, 12
Dimensions 42x56x38mm



MINIPOWER24P, 12P
Dimensions 42x56x38mm



PSU..
Dimensions 92x49x109mm

Power supplies Series - Switching mode

Totally shielded in a metallic case to prevent any kind of interference. Available with 12 or 24VDC output voltage. Isolation class: II. F connectors. Operating temperature: -10 to 55°C.

- Switch mode power supply, high efficiency and low consumption
- Plastic case suitable for fixing to a table or wall
- Protected against accidental short circuits, operation is restored after a short circuit

Item	Code	Mains voltage input Vac, Hz	Mains voltage output VDC	Max. output current mA	RF bandwidth MHz	No. of outputs	Insertion loss dB	Plug Type	Pack. Pcs
MINIPOWER12P	270020	220-230, 50-60	12	200	5-862	1	0,5	type B	1
MINIPOWER12	270021	220-240, 50-60	12	200	5-862	1	0,5	clamp	1
PSU412	289562	220-240, 50-60	12	200	5-862	2	4	type B	1
MINIPOWER24P	270023	220-240, 50-60	24	130	5-862	1	0,5	type B	1
MINIPOWER24	270024	220-230, 50-60	24	130	5-862	1	0,5	clamp	1
PSU342	289564	220-240, 50-60	24	100	5-862	2	4	-	1
PSU511**	289851	220-240, 50-60	12	200	5-2400	1	2	-	1

** DiSEqC pass-through available

Mast and indoor electronic equipment

Indoor amplifiers



AFI..



AFI Series

New range of indoor amplifiers that enable the user to amplify and distribute TV and SAT signals to every outlet, guaranteeing optimum signal level throughout the system. Compact and elegant design.

- Switch mode power supply, high efficiency and low consumption
- Screw driver included for gain and tilt adjustment
- All the adjustments are located under the panel which can be opened or completely detached
- Hidden slots for neat wall mounting
- Green LED indicates status ON

Item	Code	Inputs	Bands MHz	Gain (adj.) dB	No. of outputs	Noise figure dB	Output level* dBµV	Pack. Pcs
AFI121T	223231	1	TV (47-862)	15	2	4	111	1
AFI112T	223230		TV (47-862)	20 (15)	1	4	115	1
AFI122T	223233	1 input with return path and TV band fixed tilt	TV (88-862) RC (5-65)	10@88MHz (15) 20@862MHz (15) -4	2	5.5	115	1
AFI131T	223236	3 inputs with separate adjustments	b.I+FM (47-108) b.III (174-300) b. UHF(470-862)	24 (15) 24 (15) 30 (15)	1	4.5	117	1
AFI123T	223235	1 input with separate V/U adjustment	VHF (47-300) UHF (470-862)	30 (15) 30 (15)	2	4.5	113	1
AFI123W	223237	1 TV+SAT input with separate adjustment	TV (47-862MHz) SAT (950-2150MHz)	TV 20 (20) SAT 20@950MHz 30@2150MHz (fixed tilt 10dB) (20)	2	TV: 5.5 SAT: 6.5	117	1

* For exclusively DTT distributions the output level can be increased by 7dB (i.e. 108 analogue --> 115 digital).

General features

Power supply	Vac, Hz	220-240, 50-60
Isolation class		II
IN/OUT impedance	Ohm	75
IN/OUT connectors		F female
Band linearity	dB	±2
Max. power consumption	W	1.8, 2.5 (AFI123W)
Compliant to		EN50083-2, EN60065 Directives 89/336/CEE(EMC),73/23/CEE (low voltage)
Dimensions	mm	120x97x43
Operating temperature	°C	-10 to +55

Indoor amplifiers



MINIBOOST
Dimensions 42x56x38mm

MINIBOOST

Broadband amplifiers from internal self-powered, fully shielded with F connectors, to prevent any kind of interference.

- Lighting green LED signal operation.
- Supply voltage 230V-.

Item	Code	Inputs	Bands MHz	Gain (adj.) dB	No. of outputs	Noise figure dB	MAX Output level dBµV	Pack. Pcs
MINIBOOST	270025	1	174-790	12	2	4	115	1

Indoor modulators

MOD HD-TV series

The MOD-HDTV is a high quality DVB-T "Home" indoor digital modulator which accepts one HDMI or analog Stereo Audio/CVBS signal source and converts it into one RF DVB-T channel on its output. The excellent specs (Full HD 1920*1080-30p) and modulation quality (MER-35dB) renders the MOD-HDTV the ideal solution for distributing HD or analog TV signals coming from e.g. a Audio/Video player, laptop or CCTV camera in a domestic coax network using the DVB-T technology.

- HD source encoding (MPEG-4 AVC/H.264)
- High resolution (up to 1920 x 1080-30p for HDMI)
- High bitrate (up to 19Mb/s)
- 35dB typical MER on UHF channels
- Easy installation and start-up using the Seven Segment Display and the front panel keypad.
- USB Interface to enable advanced programming when used in conjunction with the designated software..



MOD HD-TV

Item		MOD-HDTV
Code		287400
Inputs	1	1x HDMI or 1 per CVBS (auto-back up)
Video Specs		
Video Encoding		MPEG-4 AVC/H.264
Video Bit rate	Mb/s	1 to 19
Profile		High profile 4.0
Resolution		1920x1080 30p for HDMI - 720x576@25fps for PAL
Audio specs		HDMI & mono/stereo
Stendard		MPEG-1 Layer II
Bitrate	Kbit/sec	64,96,128,192,256,320,384
Level	Vpp	0,5 to 1 (adjustable)
OUTPUT Modulation		
No. of generated MUX		1
Trasmission standards		DVB-T (EN300744)
Bandwidth	MHz	6,78
Modulation		QPSK , 16QAM, 64QAM
Carriers		2K, 8K
Guard interval		1/4, 1/8,1/16,1/32
FEC		1/2, 2/3, 3/4, 5/6, 7/8
RF OUTPUT	dB	±20
Output Frequency	MHz	174 to 230, 470 to 762
Output Channels		E5 to E12, E21 to E69
Frequency output tuning	KHz	1
Maximum output level	dBuV	90
Level Adj	dB	20
Impedance	ohm	75
Output MER	dB	35 @ UHF band
MAIN FEATURES		
RF mix input	MHz	47 to 862
RF insertion loss	dB	1 (Typical)
Power supply	Vdc, mA	12, 400max
Connectors	type	2x F female (RF), 3xRCA (analogue IN), 1xHDMI (digital IN), 1x USB (configuration)
Configurable parameters		Service Name, Service ID, Video PID, Audio PID, PMT PID, TS ID, ONID, NetworkID, Provider name
LCN standards		YES (Nordig, ITC/UK, EICTA/Europe, New Zeland)
Dimensions	mm	205x102x41
Operating Temperature	°C	0 to 50
Weight	Kg	0.3

Mast and indoor electronic equipment

Indoor amplifiers

MOD90 series

Double sideband indoor audio/video modulators. Output channel programmable via dip-switch. Stable frequency output due to PLL Synthesis and controlled via microprocessor. It distribute signals from a receiver without a modulator

- Audio/video input connection via SCART socket and high output level (90dB μ V)
- Adjustable audio/video inputs
- Multistandard output.



MOD90 - MOD90R

Item		MOD90	MOD90R
Code		280001	280002
Power supply	V		9-24
Connection	type		Coaxial cable or Jack
Max. consumption	mA		80
Video signal level	Vpp		1
Audio signal level	Vrms		1
Bandwidth	MHz		5-2300
RF output level	dB μ V		75-90 (adjustable)
Output channels		IF + E2-E12 + S1-S20 + E21-E70	
Available standards		PAL B/G, I, D/K, SECAM L, H	
RF connectors	type		F
A/V connectors	type	Pass-through scart	RCA
Dimensions	mm	100x75x30	80x75x30
Operating temperature	°C		-10 to +40
Packaging			1

Indoor amplifiers

MOD90S

Multistandard double sideband audio/video stereo A2 modulator with Crystal PLL synthesizer to set up the output frequency. The VHF and UHF frequency band and the high flexibility with multi-standard selection enable it to be used in many different installations.

- PLL crystal frequency stabilisation



MOD90S

Item		MOD90S
Code		287058
COMPOSITE VIDEO INPUT		
Frequency range	Hz-MHz	20-6
Input level/Impedance	Vpp/Ohm	0.9 - 1.1 / 75
AUDIO INPUT		
Frequency range	Hz	20 - 15,000
Input level	mVpp	775 (typ.)
Impedance	KOhm	10
Frequency deviation	kHz	±50
Level adjustment	dB	±6 (programmable)
RF OUTPUT		
Modulated output level	dB μ V	90 (typical)
Output level adjustment	dB	gen-04
Available standards		B/G, D/K, H, I, SECAM L, M/N, (programmable)
Output frequency range	MHz	47-68, 170-300, 470-862 (programmable)
RF OUTPUT		
Modulated output level	dB μ V	90 (typical)
Output level adjustment	dB	20
Available standards		B/G, D/K, H, I, SECAM L, M/N, (programmable)
Output frequency range	MHz	47-68, 170-300, 470-862 (programmable)
SUB-CARRIER FREQUENCY		
Sound 1	MHz	4.5, 5.5, 6.0, 6.5 (programmable)
Sound 2	MHz	5.742
Video carrier frequency fine tuning	MHz	±2.25 in steps 0.25 (programmable)
Sound 1 sub-carrier frequency	dB	dic-16
Sound 2 sub-carrier frequency	dB	21 ± 3
Amplitude modulation depth	%	81 (typical)
Weighted signal to noise ratio	dB	>55
Power consumption	W	2.5
Mains	Vac, Hz	230, 50
Operating temperature	°C	-10 to +40

Mast channel processor

ICP/UU MCP/UU

Agile RF converters to process analogue and digital terrestrial channels used to move a channel from its original frequency to anywhere else in the UHF band. Input and output frequencies are set by means of a built-in dip-switch.

Due to the high SAW selectivity, it can also be used as a single channel filter. Level adjustment through an internal attenuator. Input to mix all other existing channels from a different aerial.

Dual conversion technology and SAW filter to distribute adjacent channels and avoid spurious signals in the band

Fully programmable through a dip-switch
Wide dynamic input range

Input MIX to combine the output signal from another aerial

ICP/UU for indoor installations, MCP/UU for outdoor installations



ICP/UU

MCP/UU

Item		ICP/UU	MCP/UU
Code		223367	223366
Inputs	No.		2
Input 1	Band		UHF
Input 2	Band		III + S + UHF
Output	Band		III + S + UHF
INPUT 1 CONVERSION			
Input frequency	MHz		470 - 862
Channels	No.		21 - 69
Channel selection			Dip-switch
Frequency step	MHz		8
Gain	dB		15
Gain adjustment	dB		20
Phase noise	dBc/Hz		85 @ 10KHz
Maximum output level	dBμV		90 (IM3 -54dBc 2 tones)
Maximum output level	dBμV		97 (IM3 -35dBc 2 tones)
INPUT 2 MIX			
Bandwidth	MHz		47 - 862
Insertion loss	dB		-4
GENERAL FEATURES			
Mains voltage	V, Hz	220-240-, 50-60	-
Power consumption	W	06-gen	-
Supply voltage	Vdc	-	12 (from output connector)
Current consumption	mA	-	170
Operating temperature	°C		-5 to +55
Dimensions	mm	127x58x128	127x58x129
Compliant		EN60065: 2004-06 EN50083-2: 2006-06	EN50083-2: 2006-06

Installation Example

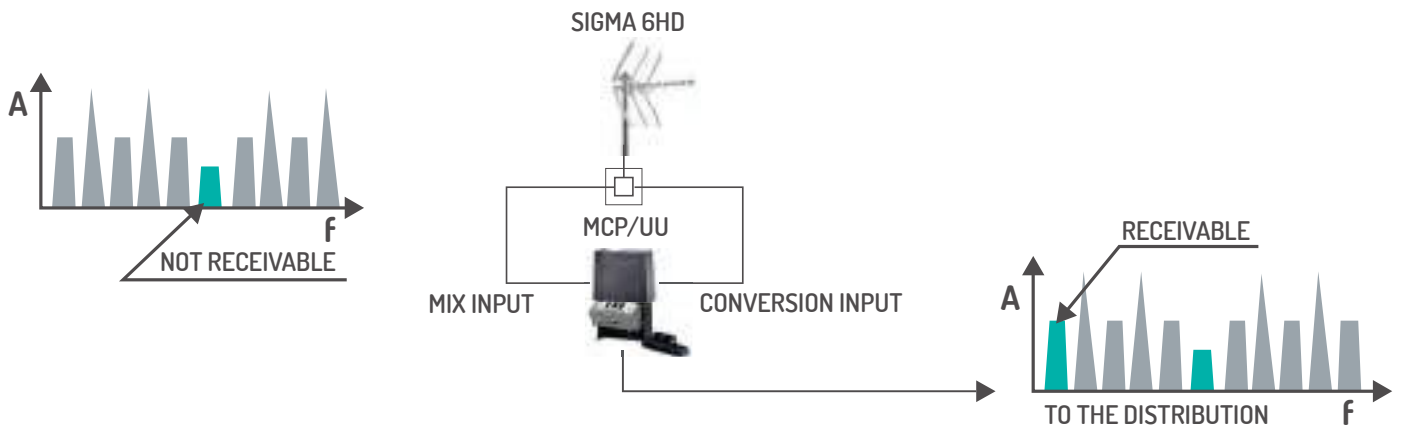

Mast and indoor electronic equipment

Multiband amplifiers



MBJ..Dimensions
127x58x128mm



MBJ Series

Multiband amplifiers to amplify and mix signals from several sources. Two versions, one 115dBμV and the other 123dBμV, to be used in small and medium networks. Metal housing, totally shielded, with plastic cover and F connectors.

- Separate amplification for VHF and UHF bands
- All the adjustments are located under the cover to prevent unauthorised access
- Switch mode power supply, high efficiency and low consumption
- Remote power supply selectable on each input, 100mA max

Item	Code	Inputs No.	Inputs / Gain dB							Output level	Noise figure VHF/UHF dB	Power cons. W
			VHF E2-S30	B.FM	B. III+DAB	B. IV	B. V	B. UHF	B. UHF			
J21B	223023	1	21	-	-	-	-	-	21	117	10	3.5
J31B	223024	1	31	-	-	-	-	-	31	117	10	3.5
MBJ2510LTE	223418	1	-	-	21	25	25	-	-	115/118	4/8	5
MBJ3610	223409		-	-	33	-	-	33	-	116/123	4/6	7
MBJ3620	223333	2	35	-	-	-	-	35	-	116/123	4/6	7
MBJ2331LTE	223416	3	-	-	21	-	-	23	23	115/118	4/8	5
MBJ3631	223322		-	-	33	-	-	33	33	116/123	4/8	7
MBJ2640	223336	4(2 out)	-	25	25	-	-	30	30	113/117	4/8	5
MBJ2340LTE	223411	4	-	-	19	22	22	22	-	115/118	4/8	5
MBJ2340/..	223414		-	-	19	22	22	22	-	115/118	4/8	5
MBJ2340/40-42	223417		-	-	19	22	22	22	-	115/118	4/8	5
MBJ2557	223300		28	FM 28	-	-	-	-	26	115/118	4/6	5
MBJ2640LTE	223412	5	-	-	30	30	30	30	-	115/120	4/8	5
MBJ2640LTE/..	223415		-	-	30	30	30	30	-	115/120	4/8	5
MBJ3640LTE	223410		-	-	33	33	33	34	-	116/123	4/8	7
MBJ2356	223313		-	21	19	22	22	22	-	115/118	4/8	5
MBJ3656	223328	-	33	31	31	32	32	-	116/123	4/8	7	

*In the standard models without suffix, band IV includes channels E21-E35 and band V includes channels E36-E60

General features		
Remote power	VDC	12, 100mA total, available on any input
Gain adjustment	dB	0 to 20 on every input
Mains voltage	Vac, Hz	220-240, 50-60
Connectors		F female
Dimensions (LxHxW)	mm	127x58x128
Operating temperature	°C	-10 to 55

Multiband amplifiers



MBX Series

Multiband amplifiers to amplify and mix signals from several sources. Die-cast housing, totally shielded with F connectors. Separate VHF and UHF band amplification on the 125dB μ V version, broadband push-pull amplification on the 130dB μ V version. High gain and high output level allow the use of these products in medium to large installations. Cover fixed with safety screws.

- Separate amplification for VHF and UHF bands
- All the adjustments are located under the cover to prevent unauthorised access
- Switch mode power supply, high efficiency and low consumption
- Remote power supply selectable on each input, 100mA max

Item	Code	Inputs No.	Inputs / Gain dB					Output level (-35dBc 2 carr.) dB μ V VHF/UHF	Noise figure dB VHF/UHF	Power cons. W			
			VHF 47-238MHz E2-S30	FM 87.5-108MHz	B. III + DAB	B. IV	B. V				B. UHF	B. UHF	B. UHF
MBX5710	235025	1	43	-	-	-	-	43	-	-	122/125	4.5/6	8.5
MBX5720	235021	2	43	-	-	-	-	43	-	-	122/125	4.5/6	8.5
MBX5540LTE	235109	4	-	-	31	30	30	30	-	-	122/125	4.5/8.5	8.5
MBX5540LTE/..	235113		-	-	31	30	30	30	-	-	122/125	4.5/8.5	8.5
MBX5541LTE	235111		-	31	30	-	-	30	30	-	122/125	4.5/7.5	8.5
MBX5740LTE	235108		-	-	38	43	43	43	-	-	122/125	4.5/7.5	8.5
MBX5740LTE/..	235112		-	-	38	43	43	43	-	-	122/125	4.5/7.5	8.5
MBX5741LTE700	235115		-	35	38	-	-	43	43	-	122/125	4.5/7.5	8.5
MBX5741LTEUK	235114		-	35	38	-	-	43	43	-	122/125	4.5/7.5	8.5
MBX7740/35-36	235105		-	-	40	40	40	40	-	-	130	11	13.5
MBX7741	235006		-	40	40	-	-	40	40	-	130	11	13.5
MBX5851⁰¹	235016		5	-	34	34	-	-	44	44	-	122/125	5/8.5

*In the standard models without suffix, band IV includes channels E21-E35 and band V includes channels E36-E60
⁰¹MBX0001 spacing kit included in the packaging.

General features		
Gain adjustment	dB	0-20 on every input
Linearity	dB	± 2
Isolation between inputs	dB	> 20
Mains voltage	Vac, Hz	Switch mode, isolation class: II 220-240, 50-60
Connectors		F, 75 Ohm
Protection		IP20
Dimensions (LxHxW)	mm	194x143x64
Operating temperature	°C	-10 to +55

Item	Code	Description
MBX0001	235000	Accessories kit composed of no. 2 plastic supports & mounting screws, used to install the MBX series leaving a space between the amplifier and the wall. Packaging 10 pcs.

Mast and indoor electronic equipment

Headend amplifiers



AMP9764 - AMP9564

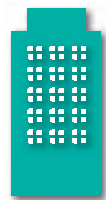

AMP Series

Mains powered amplifiers to amplify satellite signals with passive loop-through of the TV signal. To be used as a launch amplifier in IF systems or as a SAT line amplifier. They allow gain and slope adjustment in the SAT band. Cover fixed with safety screws. No DC pass from the output to the inputs. For installation, supports are available (item MBX0001, see page 62) that leave a space of 19mm between the amplifier and the wall, allowing room for cables or the amplifier to be mounted in different positions.

- LNB power supply: 0V, 14V, 18V, 0/22Hz
- Low insertion loss in RF band
- Switch mode power supply, high efficiency and low consumption
- All the adjustments are located under the cover to prevent unauthorised access

Item	Code	Inputs No.	Bandwidth MHz	Gain dB	Gain adjustment dB	Tilt adjustment dB	Output level dB μ V	Noise figure dB
AMP9762	235051	1	5-30 47-862	25 40	- 0-20	- 0-20	101 121	3 8
AMP9762B	235055		5-65 88-862	25 40	- 0-20	- 0-20	101 121	3 8
AMP9763	235052	1	5-30 47-862 950-2400	25 40 40	- 0-20 0-20	- 0-20 0-20	101 121 125	3 8 10
AMP9763B	235056		5-65 88-862 950-2400	25 40 40	- 0-20 0-20	- 0-20 0-20	101 121 125	3 8 10
AMP9764	235053		940-2400 47-862	40 -2	0-20 -	15 -	125 -	10 -
AMP9564	228371	2	950-2150 5-862	37@950MHz, 43@2150MHz -2	0-20 -	10 -	120 -	<7 -

General features

Test socket	dB	- 30	Flatness	dB	\pm 2
Mains voltage	Vac, Hz	220-240, 50-60	Connectors	F	
Power consumption	W	AMP9762, AMP9562B: 9 AMP9763, AMP9563B: 16 AMP9764, AMP9564: 11	Protection	IP20, for internal use	
Impedance	Ohm	75	Operating temperature	$^{\circ}$ C	-10 to +55

Programmable equaliser filters



FIL10

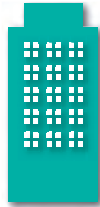

FIL Series

FIL Series is the new range of highly selectable programmable cluster headends designed by Fracarro's internal R&D department. It is suitable to filter from 1 up to 6 channels for each cluster, selectable.

- Programmable using the built-in keypad and LCD display or using a PC based software
- Possible to copy the configuration from a headend to another one by means of a USB pen drive, quickly and easily
- "Clusters autoalignment" function for automatic gain adjustment which enables equalised output signals and a better noise figure
- Clusters can be split over 3 different UHF inputs through a completely flexible matrix
- Heat dissipation by natural convection, no fans required, reducing maintenance costs

Item	FIL 10			
Code	272108			
Inputs	B. III+DAB	UHF1	UHF2	UHF2
Frequency	MHz	174-320	470-862	470-862
Selectable cluster on inputs	UHF1 UHF2 UHF3	- - -	8,9,10 5,6,7,8,9,10 1,2,3,4,5,6,7,8,9,10	
Gain	dB	18	18	18
Dynamic adjustment (on each input)	dB	20	20	20
Cluster adjustment	dB	-	20	20
Max. input level	dB μ V	100	90	90
Max. output level	dB μ V	90	90	90
Remote power (max. 250/100mA)		-	12/24V	12/24V

General features	FIL 10	
Cluster selectivity	dB	20@10MHz
Cluster bandwidth	MHz	8-48 (1-64ch)
IN/OUT return loss	dB	>10
Mains	Vac	220-240
Power consumption	W	25 (FIL 10), 20 (FIL 06)
Noise figure (III+DAB, UHF)	dB	6.6
Operating temperature	°C	-5 to +50
Dimensions	mm	230x230x50 (FIL 10), 160x230x50 (FIL 06)

Mast and indoor electronic equipment

Programmable headends

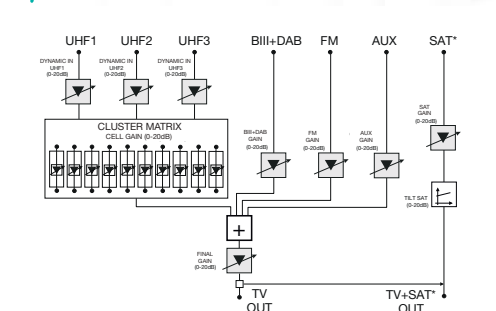

FRPRO.. Series

FRPRO is the new range of highly selectable programmable cluster headends designed by Fracarro's internal R&D department. Available in 4 versions, the headends enable different TV channels to be filtered and amplified. The clusters in the UHF band can be programmed for each channel, from 1 to 6 channels. For the FRPRO10x Series the maximum number of clusters is 10, this means the headend can distribute up to 60 channels (6 channels x 10 clusters).

- Programmable using the built-in keypad and LCD display or using a PC based software
- Possible to copy the configuration from a headend to another one, either the same model or a headend belonging to the range by means of a USB pen drive, quickly and easily
- "Clusters autoalignment" function for automatic gain adjustment which enables equalised output signals and a better noise figure
- Clusters can be split over 3 different UHF inputs through a completely flexible matrix
- Heat dissipation by natural convection, no fans required, reducing maintenance costs

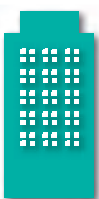

Item	FRPRO10 - FRPRO10 HD						
Code	272102 - 272110						
Inputs	No.	FM	B. III+DAB	AUX	UHF1	UHF2	UHF3
Frequency	MHz	88-108	174-300	47-862	470-862	470-86	470-862
Selectable cluster on inputs	UHF1 UHF2 UHF3	- - -	- - -	- - -	- - -	8, 9, 10 5, 6, 7, 8, 9, 10	1, 2, 3, 4, 5, 6, 7, 8, 9, 10
Gain	dB	46	46	36	43 (PRO10) 38 (PRO10HD)	43 (PRO10) 38 (PRO10HD)	43 (PRO10) 38 (PRO10HD)
Dynamic adjustment (on each input)	dB	20	20	20	20	20	20
Cluster adjustment	dB				20	20	20
Master level adjustment	dB	20	20	20	20	20	20
Max. input level	dB μ V DTT	90	85	110	90	90	90
Max. output level	dB μ V DTT	120 (PRO 10HD) - 121 (PRO 10)					
Remote power (max. 250/100mA)		No	No	No	12/24V	12/24V	12/24V

General features		
Cluster selectivity	dB	20@10MHz
Cluster bandwidth	MHz	8-48 (1-64ch)
IN/OUT return loss	dB	>10
Outputs	1 + 1 for test (-25dB) + 1 TV/SAT (FRPRO 10S only)	
Mains	Vac	220-240
Power consumption	W	19 (FRPRO 06) / 23 (FRPRO 10) 25 (FRPRO 10A) / 32 (FRPRO 10S)
Operating temperature	°C	-5 to +50
Noise figure (FM, III+DAB, UHF, AUX)	dB	6, 6, 6, 10

Headends

Compact Headends

SAF-HD series	64
D-MATRIX series	66
3DGFLEX series	70
COMPACT LINE series	72
DIGIFLEX series	74

Mid Level Headends

K Series	76
120dB μ V output channel amplifiers	76
TV Band amplifiers	77
QPSK-COFDM FTA transmodulator	77
Digital QPSK receiver with fullband DSB modulator	78
QPSK receivers with fullband vestigial sideband modulator	79
COFDM receivers with fullband vestigial sideband modulator	80
Agile channel processor	81
Analogue fullband modulators	82
SAT amplifiers+TV mixer	83
Transponder amplified selective filter	83
Programmable IF-IF DVB-S2 converter	83
TV push-pull final amplifiers	84
Power supplies	84
Programming Unit	85
Accessories	85
Plug-in "F" bridges	85
Shielded quick push "F" bridges	85
Shielded twiston bridges	86
Broadband pre-amplifiers	86

High Level Headends

Headline series	87
COFDM receivers	88
SAT receivers	89
Analog modulators	90
COFDM modulators	91
Professional encoders	92
IP encoders (FTA)	93
IP encoders from TS	93
Optical transmitter	94
Optical splitters	94
Interconnection module	95
Sub rack and accessories	95
Accessories	96
19" rack cabinets	97
19" rack accessories	97

Headends

Compact Headends

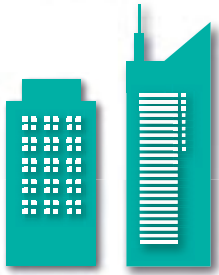

SAF-HD 10

SAF-HD series

MATV Mid level Headends to filter DVB-T and DVB-T2 signals including 7 or 10 UHF agile active filters with very high selectivity and AGC (Automatic Gain Control) circuit to keep the output level stable when the signals at the aerial are floating. All the filters can be set via the on-board programmer (or via PC) to any UHF frequency and can even be used as a channel converter in the same frequency band. The VHF input allows to filter and amplify the FM and the VHF bands with separate adjustment. The SAF headend is ideal to distribute signals with perfect equalisation and high quality to the network distribution with a high power level in order to reach those longer distances.

- Perfect for High Definition (HD) and Standard Definition (SD) DTT multiplex due to the very low phase noise.
- UHF agile filters equipped with SAW technology providing high selectivity.
- USB port to upload/download via USB the settings to another headend.
- Auto equalisation function to give a perfect levelling of the distributed signal saving on installation time.
- Remote power supply for mast amplifier available on any UHF input, 12V, selected via software.
- 100dB μ V power level per channel to reach longer distances directly from the headend.

Features

Installation Example

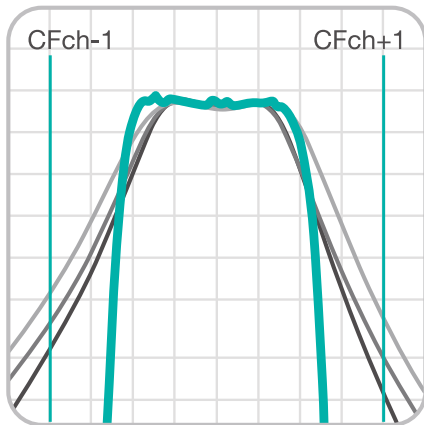

- SAF-HD
- ≡ Resonant circuits

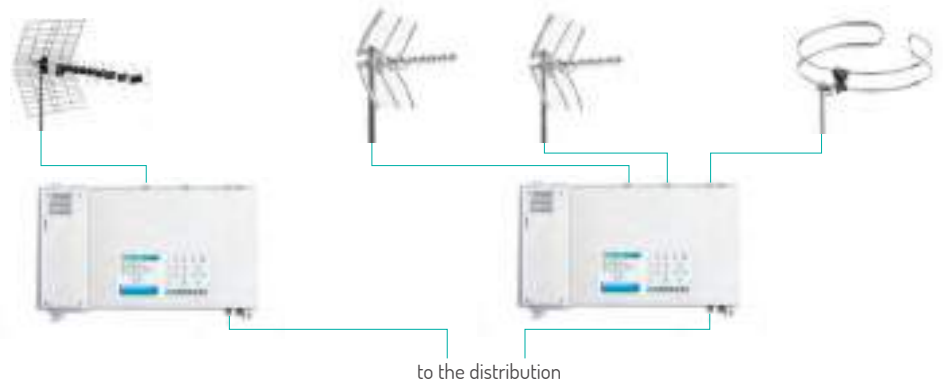
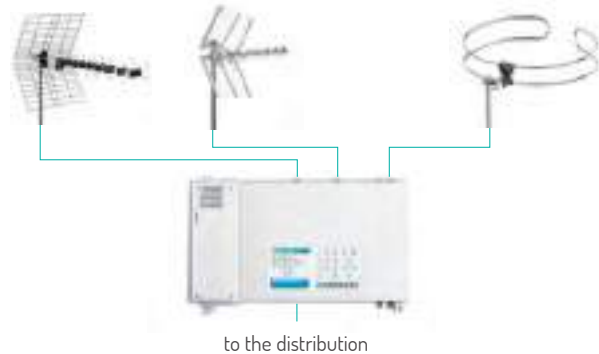

Item		SAF-HD 10	SAF-HD 7
Code		272008	272009
UHF filter characteristics			
Filters	No.	10	7
Input frequency	MHz	470-862	
Input level	dB μ V	50-73 (for 40 channels)	
Max. input power	dB μ V	90 (for each UHF input)	
Filter bandwidth	MHz	8	
Filter selectivity	dB	$\geq 50 @ C_f \pm 5$ MHz	
AGC dynamic	dB	23	
Flatness	dB	± 1	
Level adjustment	dB	10 (1dB steps)	
Frequency offset	KHz	500 (125KHz steps)	
Frequency accuracy	KHz	70	
FM + VHF filter characteristics			
Input frequency	MHz	87-108, 174-240	
Input level	dB μ V	VHF/DAB: 53-73, FM: 60-80	
Max. gain	dB	VHF/DAB: 45, FM: 40	
Gain adjustment	dB	VHF/DAB: 20, FM: 20	
Output signal			
Max. output power	dB μ V	100 per channel	
Output level adjustment	dB	15	
Test output	dB	-25	
Noise figure	dB	9	
General features			
Remote power supply	V	12 on each UHF input, selectable via software	
Max. remote supply current	mA@V	200@12	
Mains voltage	Vac, Hz	184-264, - 50-60, Class: II	
Consumption	W	33	30
Connectors	Type	F female	
Input demixing		Input 1: filter 1-3, Input 2: filter 1-6, Input 3: filter 1-10	
Compliant		EN50083-2, EN60065	
Operating temperature	$^{\circ}$ C	-10 to +55	
Dimensions	mm	360x225x60	

Headends

Compact Headends



D-MATRIX series

The new D-Matrix compact headend range will introduce a revolutionary concept: a unique mechanics is able to receive many satellite or digital terrestrial contents, in HD or SD standard definition, coming from different and independents inputs and remodulate them on "customized" RF output multiplexes.

Thanks to the universal slots, the compact headend can decrypt the desired programs by using the proper CAM and professional smart cards.

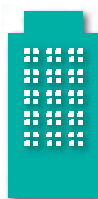

COMMON FEATURES:

- Fully manageable parameters for all the muxes and individual programs (LCN, SID, PDSID, NIT, ...).
- **New absolute feature:** USB Audio/Video file playback (TS file format).
- **"Mux-ad-Hoc":** you can create a mux with the choosen programs from up to 4 satellite transponders and manage all the descriptor parameters of each mux (ONID, TSID, NetID,...) and each program inside the mux (LCN, SID, PID, Program name..).
- **ARP 2.0:** Automatic Recovery Procedure to save the higher priority programs and guarantee Continuity of Service when bit rate overflows occur. All the program are sequentially restored when the global bit rate returns within the limits.
- **AUTO REMAPPING function:** you can change in real time the program inside the mux **without rescanning all the TV set along the network.**
- **WEB interface based headend:** setup, and configuration must be done by using web interface built-in; basic setup available by on board keyboard.
- **USB Port** to upload/download presets or for the firmware upgrade, videoplayback (TS file format).

Installation Example

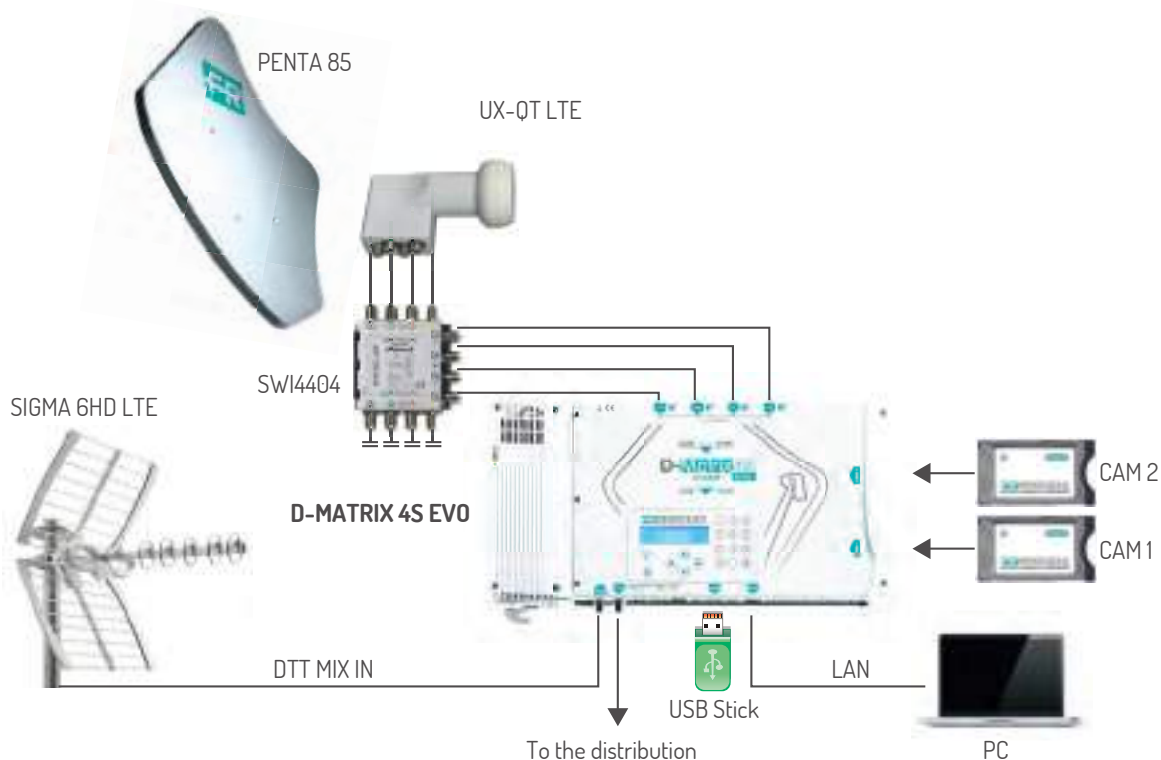

Compact Headends

D-MATRIX S

D-MATRIX 4S

The new D-Matrix 4S compact headend (basic version)

- **Multi SAT Input:** 4 independent SAT input (DVB-S2),
- Generating 2 DVB-T or DVB-C “ad Hoc” muxes giving the installer the flexibility to choose the contents to be distributed.
- **2 Common Interface slots**
- **USB Port** to upload/download pre-settled setup or for the firmware upgrade, videoplayback (TS file format).

Item		D-MATRIX 4S
Code		283131
Front-End		
Input	No.	4
Input frequency,	MHz	950÷2150
Input level	dB μ V	50÷80
Input step tuning	MHz	1
LNB control		0/14/18VDC, 0/22KHz, DiSEqC 1.0
Demodulation		DVB-S2 (8-PSK, QPSK), DVB-S (QPSK)
FEC		1/2, 2/3, 3/4, 5/6, 7/8, AUTO
Symbol rate	MS/sec	2 ÷ 45 (DVB-S/ DVB-S2)
AFC Range	MHz	-5 ÷ +5
Output Modulation		
Generated mux	No.	2
Trasmission standard		DVB-T / DVB-C
Bandwidth	MHz	6, 7, 8 / (depends on the output SR that was set)
Carriers	k	2, 8 / -
Modulation		QPSK, 16-QAM, 64-QAM / 16QAM, 32 QAM, 64QAM, 128QAM, 256QAM
Guard interval		1/4, 1/8, 1/16, 1/32 / -
FEC		1/2, 2/3, 3/4, 5/6, 7/8 / Reed Solomon (204, 188)
Symbol Rate	Msymb	- / 1000 to 6999
Spectrum		Normal, Inverted
Operating Mode		Normal, Single Carrier
RF Output		
Output frequency	MHz	111÷862
Output channels		S2÷E69
Output step tuning	KHz	250
Typical RF output level	dB μ V	100
Output level adjustment	dB	0÷20
Flatness		± 1.5
Typical Output MER	dB	36
Spurious rejection	dBc	< -50
General Features		
RF mix input	MHz	47÷862
RF insertion loss	dB	2.5
Mains Supply	Vac, Hz	184-264, 50/60
Typical Power Consumption	W	42 (with two CAMs inserted)
Connectors	Type	2x F female (RF), RJ45 (programming via web interface), USB (fw upgrade, TS video file playback)
Common Interface		2 x PCMCIA (Standard EN50221, TS10169)
Dimensions (L.× W.× H)	mm	360x230x54 (without CAM inserted) - 385x230x54 (with CAM inserted)
Operating temperature	°C	-5 ÷ +55 (without CAM)
Compliant		EN50083-2, EN60065

Headends

Compact Headends



D-MATRIX 4S EVO

D-MATRIX 4S EVO

The new D-Matrix 4S EVO satellite compact headend.

- **DVB-T/DVB-C “agile output modulation” selectable via software:** one product to fit every coax network distribution
- **Multi SAT Input:** 4 independent SAT input (DVB-S2).
4 DVB-T or DVB-C output mux (two pairs of adjacent digital modulators).
- **2 Common Interfaces slots.**
- **Optimized CAMs Management.** Two different operation modes available:
 - **Flex CAM mode:** it can be forwarded to the same CAM module the programs coming from any SAT input (i.e. Flexible CAM on the OUTPUT)
 - **STANDARD mode:** each CAM module can be associated with a SAT input in order to decrypt the encoded programs coming only from this specific input.
- **WEB interface based headend:** today the setting are even more intuitive.

Item		D-MATRIX 4S EVO
Code		283132
Front-End		
Input	No.	4
Input frequency	MHz	950÷2150
Input level	dBµV	50÷80
Input step tuning	MHz	1
LNB control		0/14/18VDC, 0/22KHz, DiSEqC 1.0
Demodulation		DVB-S2 (8-PSK, QPSK), DVB-S (QPSK)
FEC		1/2, 2/3, 3/4, 5/6, 7/8, AUTO
Symbol rate	MS/sec	2 ÷ 45 (DVB-S/ DVB-S2)
AFC Range	MHz	-5 ÷ +5
Output Modulation		
Generated mux	No.	4 (two pairs of adjacent digital multiplexes)
Transmission standard		DVB-T / DVB-C
Bandwidth	MHz	6, 7, 8 / (depends on the output SR that was set)
Carriers	k	2, 8 / -
Modulation		QPSK, 16-QAM, 64-QAM / 16QAM, 32 QAM, 64QAM, 128QAM, 256QAM
Guard interval		1/4, 1/8, 1/16, 1/32 / -
FEC		1/2, 2/3, 3/4, 5/6, 7/8 / Reed Solomon (204, 188)
Symbol Rate	Msymb	- / 1000 to 6999
Spectrum		Normal, Inverted
Operating Mode		Normal, Single Carrier
RF Output		
Output frequency	MHz	111-862
Output channels		S2±E69
Output step tuning	KHz	250
Typical RF output level	dBµV	95
Output level adjustment	dB	0÷20
Flatness		± 1.5
Typical Output MER	dB	36
Spurious rejection	dBc	< -50
General Features		
RF mix input	MHz	47±862
RF insertion loss		2.5
Mains Supply		Vac, Hz 230,50/60
Typical Power Consumption		W 42 (with two CAMs inserted)
Connectors		Type 2x F female (RF), RJ45 (programming via web interface), USB (fw upgrade, TS video file playback)
Common Interface		2 x PCMCIA (Standard EN50221, TS10169), Flex Cam or STANDARD mode
Dimensions (L.× W.× H)		mm 360x230x54 (without CAM inserted) – 385x230x54 (with CAM inserted)
Operating temperature		°C -5 ÷ +55 (without CAM)
Compliant		EN50083-2, EN60065

Compact Headends

D-MATRIX 8T

The new D-Matrix 8T digital terrestrial compact headend

- **Digital Terrestrial mux regeneration and recovery:** it's possible to tune and regenerate up to 8 input digital terrestrial multiplexes.
- **Compact headend suitable for distribute the Pay TV terrestrial content on the collective environment**
- **Multi TV input:** 8 TV input tuners (DVB-T2/T or DVB-C) that are connected in pair to the four coax input connectors,
- 8 DVB-T (2K) output mux (two raster of four adjacent digital modulators each one)
- **2 Common Interface slots.**
- **Optimized CAMs Management.** Two different operation modes:
 - **Flex CAM mode:** it can be forwarded to the same CAM module the programs coming from any SAT input (i.e. Flexible CAM on the OUTPUT)
 - **STANDARD mode:** each CAM module can be associated to a TV input in order to decrypt the encoded programs coming only from this specific input.



D-MATRIX 8T

Item		D-MATRIX 8T
Code		283133
Front-End		
Input	No.	8 TV tuners (two tuners coupled to every F input connectors)
Input frequency	MHz	110÷862 (170-862 for the first coax input)
Input level (typical)	dBµV	55÷85
Impedence	Ohm	75
Remote power supply	Vdc, mA	12, 200 (max)
Demodulation		
DVB-T2, DVB-T or DVB-C		
Input step tuning	KHz	10
AFC Range	KHz	±400 (DVB-T2/T), ±100 (DVB-C)
Output Modulation		
Generated mux	No.	8 (two group of four adjacent digital modulator)
Trasmission standard		DVB-T
Bandwidth	MHz	6, 7, 8
Carriers	k	2k
Modulation		
QPSK, 16-QAM, 64-QAM		
Guard interval		
1/4, 1/8, 1/16, 1/32		
FEC		
1/2, 2/3, 3/4, 5/6, 7/8		
Spectrum		
Normal, Inverted		
Operating Mode		
Normal, Single Carrier		
RF Output		
Output frequency	MHz	110÷862
Output channels		
52÷E69		
Output step tuning	KHz	250
Typical RF output level	dBµV	95
Output level adjustment	dB	0÷20
Flatness		
± 1.5		
Typical Output MER	dB	36
Spurious rejection	dBc	< -50
General Features		
RF mix input	MHz	47÷862
RF insertion loss	dB	2.5
Mains Supply	Vac, Hz	230, 50/60
Typical Power Consumption	W	42 (with two CAMs inserted)
Connectors	Type	2x F female (RF), RJ45 (programming via web interface), USB (fw upgrade, TS video file playback)
Common Interface		
2 x PCMCIA (Standard EN50221, TS10169), Flex Cam or STANDARD mode		
Dimensions (L.× W.× H)	mm	360x230x54 (without CAM inserted) – 385x230x54 (with CAM inserted)
Operating temperature	°C	-5 ÷ +55 (without CAM)
Compliant		EN50083-2, EN60065

Headends

Compact Headends

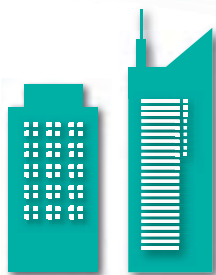

3DGFLEX series

The 3DGFLEX is a modular headend designed to process a range of digital signals ready to be distributed over a centralised system, such as large apartment buildings or hospitality environments, by using a combination of different twin modules it's possible to perform a remultiplexing of different contents (satellite or DTT programs, ASI sources) and distribute them on the centralized coaxial network.

- **Auto Remapping Function:** You can change a program in real time within the mux without the need to retune all the TV sets in the system.
- **MUX ad Hoc agile QAM or DTT:** Create a mux with the chosen programs from up to 3 different sources (two connectors and one TS available coming from back panel) and manage all the descriptor parameters: just drag and drop the available channels into the mux.
- **Web based interface:** The headend can be remotely programmed or monitored anytime or anywhere (PC and mobile). When a change is detected in the users configuration an alert e-mail is automatically sent.
- **ARP 2.0:** Automatic Recovery Procedure to save the higher priority programs and guarantee Continuity of Service when bit rate overflows occur. All the program are sequentially restored when the global bit rate returns within the limits.
- **FPGA technology:** enables a flexible and efficient way of upgrading a system, using the latest state of the art technology.
- **Back panel** loop-through of the signals from previous modules.
- **Remote management** included to monitor and edit the set up of the headend remotely.
- **USB Port** to upload/download pre-setted set up or for the firmware upgrade

Installation Example

3DGFLEX - using a LNB to distribute signals to all receivers

3DGFLEX - using a MSW to distribute signals to all receivers

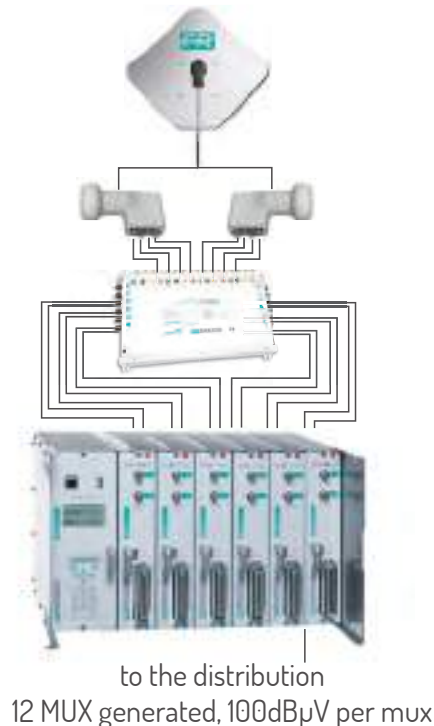



Item		3DG-2S2-2T	3DG-2T2-2T	3DG-2ASI-2T
Code		283157	283159	283160
Inputs		SAT	TV	ASI
Input	No.	2	2	2
Input frequency	MHz	950-2150	174-862	-
Input level	dB μ V	48-80	40-85	-
LNB control	VDC, KHz	0/14/18, 0/22	12, -	-
Demodulation		DVB-S, DVB-S2	DVB-T2, DVB-T, DVB-C	-
Symbol rate	MS/sec	DVB-S: 2-45, DVB-S2: 2-30	-	-
Max input bitrate	Mbit/s	-	-	214
Common interface		2 slot PCMCIA (EN 50221 TS10169)	2 slot PCMCIA (EN 50221 TS10169)	-
Modulation DVB-T				
Generated muxes	N°		2	
Bandwidth	MHz		6, 7, 8	
Modulation			QPSK, 16-QAM, 64-QAM	
FEC			1/2, 2/3, 3/4, 5/6, 7/8	
Modulation DVB-C				
Generated muxes	N°		2	
Bandwidth			(depends on the output SR that was set)	
Modulation			16QAM, 32 QAM, 64QAM, 128QAM, 256QAM	
FEC			Reed Solomon (204, 188)	
RF Output				
Output frequency	MHz		111-862 (S2-E69)	
Max. output level	dB μ V		102	
Output MER	dB		\geq 36	



Item		3DG-BOX	3DG-BOX-PC (version without keyboard)
Code		283156	283161
Maximum number of modules	No.		6
RF mix input	MHz		47-862
RF insertion loss	dB		2.5
Mains Supply	Vac, Hz		184-264, 50/60
Power consumption	W		105 (no CAM)
Connectors	type	F female (RF), RJ45 (programming and remote monitoring), USB (FW upgrade)	
Dimensions (L. \times W. \times H)	mm	415 x 260 x 265	
Operating temperature	$^{\circ}$ C	-10 to +50 (without CAM)	
Compliance		EN50083-2, EN60065	



3DG-FRONT PANEL
Code 283158
blind panel for 3DGFLEX

Headends

Compact Headends



SIG9506

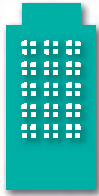

COMPACT LINE series

Compact headend for the reception and distribution of 6 digital satellite channels. It demodulates and remodulates them into the entire RF band. Compact headend includes 6 QPSK receivers, 6 A/V modulators, 6-way combiner with existing TV signal mixing, power supply and programming unit with backlit display. A/V outputs are available to connect external modulators.

Earth bounding connection. Compliant to EN50083-2.

- Fullband modulator (174-446MHz + 470-867MHz)
- Easy to install, all items are included in one box
- Each single receiver can generate 14 or 18V, 22KHz tone and DiSEqC 1.0, suitable to feed an LNB or to control a multiswitch output
- Software available to set up the headend using a PC (using item KRS-RJ, not included)
- Software can be upgraded on site (using item KRS-RJ, not included)
- Heat dissipation by natural convection, no fans needed, reducing maintenance costs

Installation Example

Connecting several receivers to the same polarity

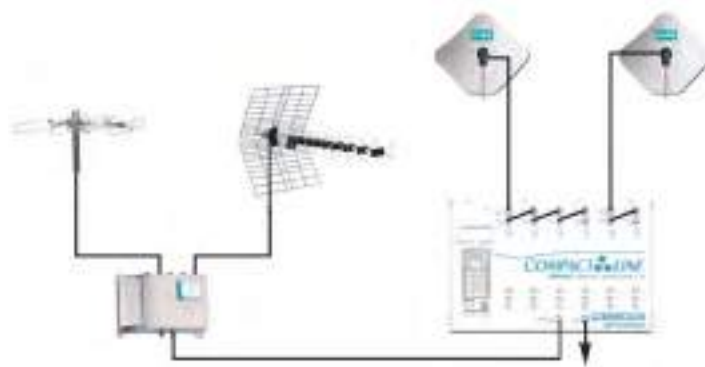

Using a multiswitch to distribute signals to all receivers



Item	SIG9506	
Code	283126	
Inputs SAT QPSK		
Input frequency	MHz	950-2150
Input level	dB μ V	45-80
Impedance	Ohm	75
Bandwidth	MHz	36
Input step tuning	MHz	1
Loop-through insertion loss	dB	-4 to +4
Max. no. of modules possible to loop-through	Depends on the frequency and the level of the input signal	
DiSEqC	1.0 ,4 positions 0/14/18V, 0/22KHz	
LNB power supply	mA, V	Max. 400 @14
QPSK demodulation		
AFC range	MHz	-2.5 to +2.5
Symbol rate	M symb/sec	2-35 (compatible SCPC/MCPC)
FEC	Auto	
MPEG specification		
Video decoder	MPEG-2 Main profile, Main level (MP@ML)	
Audio decoder	MPEG-2 Layer I and Layer II	
Colour standard	PAL/SECAM/NTSC	
Video format	4:3, 16:9, pan scan, letter box	
Audio format	Mono, language 1, language 2	
A/V outputs		
Video type	Composite	
Video level	V _{pp} -Ohm	1-75
Max. audio level	Ohm, mVrms	600-600
Band frequency	Hz	20-15000
TV modulator		
Modulator	DSB (double sideband)	
Standard	PAL (B/G, D/K, I, N, H), SECAM L, NTSC M	
Output frequency (channels)	MHz	VHF: 174-446 (E5-S38) - UHF: 470-862 (E21-E69)
Output level	dB μ V	100
Output level adjustment	dB	10 (independent for every channel)
Audio level adjustment	dB	0-10
S/N weighted	dB	52 typ.
Output channel programming	By frequency (steps of 250KHz) or by channel	
No. of outputs	2 outputs (output and mix input)	
TV modulator		
TV mixing input	MHz	47-862
TV mixing insertion loss	dB	2
Test signal	Black screen or white rows to be used for radio signal distribution	
General features		
Input connectors	2 x F connectors (input + loop-through) for every channel	
Output connectors	2 F connectors (output and mix input)	
A/V output connectors	3 x RCA connector for every channel	
Mains voltage	Vac, Hz	220-240, 50-60
Power consumption	W	63
Compliant	EN50083-3, EN60065	
Dimensions	mm	370x240x150
Operating temperature	°C	-10 to +45

Headends

Compact Headends



SIG9506

DIGIFLEX

SMATV headend for the reception and distribution of 8 digital satellite channels. Demodulates 8 digital channels and remodulates them into the RF band (47-862MHz). The front panel is removable with a lock to avoid common interface modules or cards being removed. Wall mount or 19" cabinet installation.

- Easy to install, included in one box: power supply, 8 QPSK receivers with common interface slot, 8 A/V vestigial sideband modulators, wideband (47-862MHz) with audio stereo, combiner to mix 8 RF channels, final amplifier 98dB μ V per channel
- Two A/V input/output connectors are available to connect external devices (DVD players, cameras, etc.)
- Master/slave setting available to share one smart card among several receivers, to decrypt several programs with only one subscription (if allowed by the pay-TV service provider).
- SIG9708CI: each receiver can generate 14 or 18V, 22KHz tone and DiSEqC 1.0, suitable to feed an LNB or control multiswitch output
- WSS signals compatible for the auto-adjustment of the TV video formats
- Heat dissipation by natural convection, no fans required, reducing maintenance costs
- Software available to set the headend using a PC

Installation Example

Connecting several receivers to the same polarity

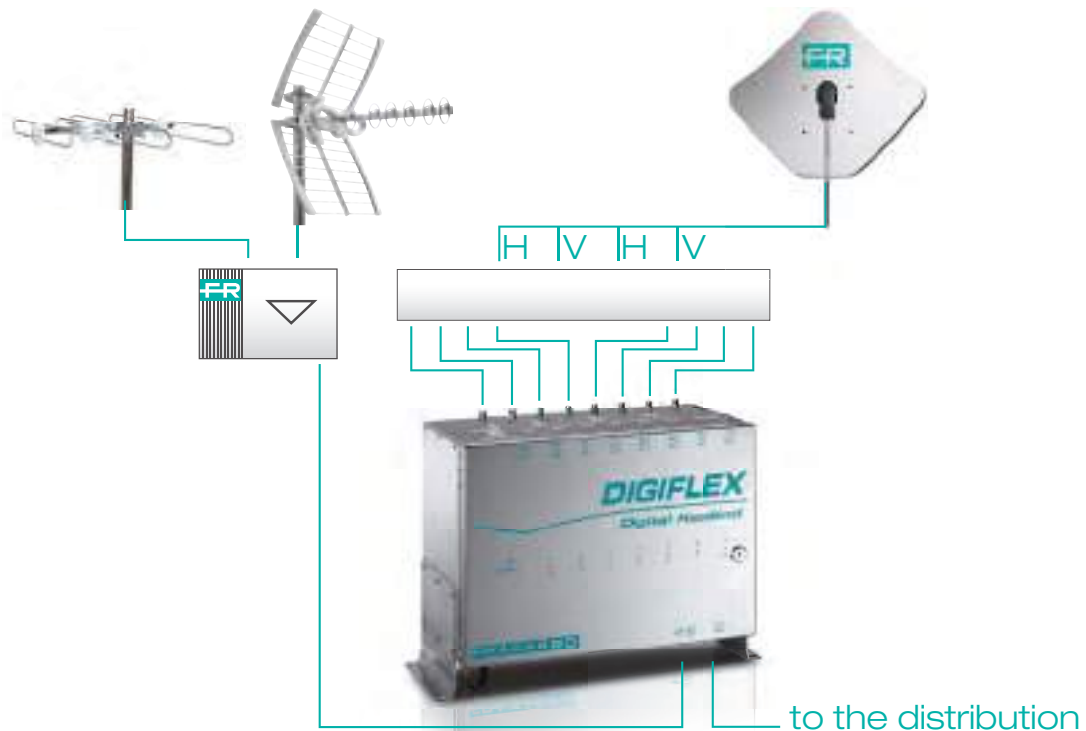

Item		SIG9708CI
Code		283141
SAT QPSK INPUT		
Input frequency	MHz	950-2150
Input level	dBuV	45-80
Impedance	Ohm	75
Bandwidth	MHz	36
Input step tuning	MHz	1
AFC range	MHz	-3 to +3
LNB power supply		0/14/18VDC, 0/22KHz, max. 400@14VDC, DiSEqC 1.0
QPSK demodulation		
Symbol rate	Mymb/sec	1-45 (compatible SCPC/MCPC)
FEC		1/2, 2/3, 3/4, 5/6, 7/8, auto
MPEG specification		
Video decoder		MPEG-2 Main profile, Main level (MP @ ML)
Audio decoder		MPEG-2 Layer I and Layer II
Colour standard		PAL
Video format		Adapted 16:9, pan scan, letter box, combined
Audio format		Stereo, dual sound
Teletext		Yes
TV modulator		
Modulator		VSB
Standard		PAL B/G Stereo
Output frequency	MHz	47-862
Channels	MHz	E2-E69
Output level	dBuV	98
Output level adjustment	dB	10 (independent for every channel)
Audio level adjustment	dB	10 (adjustment steps)
S/N weighted	dB	54
Output channel programming		By frequency (steps of 250KHz) or by channel
No. of outputs		2 outputs (output and mix input)
TV mixing input	MHz	47-862
TV mixing insertion loss	dB	4
Test signal		Black screen or white rows to be used for radio signal distribution
General features		
Input connectors		1 F connector for every channel
Output connectors		2 F connectors (output and mix input)
A/V input connectors		2 x SUB-D 15 pin
Programming unit		TPE (not included)
Mains voltage	Vac, Hz	220-240, 50-60
Power consumption	W	130
Compliant		EN50083-2, EN60065, EN50221, ETSI TS101699
Operating temperature	°C	-10 to +45

Headends

Mid Level Headends



K Series

K series

Modular MATV/SMATV systems, the design targets of the K series are:

- Easy installation and maintenance
- Flexibility in the unit/headend composition (particularly for the integration between traditional TV, satellite TV and satellite IF)
- Solid and inexpensive without compromising performance
- Ready for future product ranges
- Compliant with all European and international regulations in force, including electromagnetic compatibility (mark, according to 2004/108/EC directive).

The main features of K series products are:

- All products are fully compatible with digital (TV & SAT) programs
- Fixing to a standard DIN bar provides good mechanical strength and maximum density when assembling the headends. It also allows the use of a wide range of standard accessories available on the market
- Single voltage feed (12V, negative). A local power supply is provided where necessary. It is quick and easy to replace and keeps spare parts down to a minimum
- All modules have a solid mechanical structure. In particular, channel filters – where dimensional stability and surface conductivity are critical features – come in die-cast small silver plated boxes
- For RF connections, all modules use “F” connectors with quick fit interconnection bridges
- Wide range of products dedicated to digital terrestrial and satellite signals. They perfectly integrate with existing headends, fulfilling any installation requirement
- Adjacent channel distribution is possible due to the channel filters selectivity together with the vestigial sideband (VSB) modulators used in satellite receivers
- Active filters for digital terrestrial have been developed using the KF and K120 active channel filters. These have been calibrated specially for the distribution of new COFDM modulated signals
- 19” rack installation possible
- Software can be upgraded on site using the KRS-RJ adaptor (not included)
- Programmable using a TPE or via FHM software (not included)

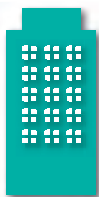

120dB μ V output channel amplifiers

Channel amplifiers with five resonant circuits. Excellent selectivity allows the distribution of adjacent channels. The SMD amplification card ensures a high degree of reliability and accuracy. Operating temperature: from -10° to $+55^{\circ}\text{C}$.



K120L

(*) the desired channel must be specified during the order. Refer to the appendix for the list of all available channels.

(**) possible to adjust the amplifier to a different standard on request

Item		K120/FM	K120L/.B3 (*)	K120L/xxDT (*)
Code		270271	270885	2708xxDT
Frequency / Channel	MHz	FM	E5-E12	E21-E60
Gain (Adjustment)	dB	40 (40)	45 (40)	45 (30)
Selectivity (**)				
PAn-2	dB		40	42
PAn-1	dB		5	10
PAn+1	dB		10	16
PAn+2	dB		44	46
Max output level	dB μ V	112	120	120
Noise figure	dB	5	9	9
Max power consumption	mA	200@12VDC	180@12VDC	200@12VDC

TV Band amplifiers

These are provided with three channel traps to equalise the input channels or to eliminate unwanted channels. Each trap has 15dB attenuation and can be tuned by the installer. The KFB4 and KFB5 can be placed alongside the channel filters being careful not to tune to future channel requirements. They use the same mechanical structure as the K series, with F connectors and a self mixed output.



KFB..

Item		KFB3	KFB4	KFB5	KFB5/..	KFBU
Code		270063	270054	270055	270062	270064
Bandwidth	MHz	174-240	470-590	606-862	606-862 start channel on request	470-862
Gain (Adjustment)	dB	31 (20)	13 (20)	11 (20)	11 (20)	31 (20)
Return loss Input	dB	10	10	10	10	10
Return loss output	dB	10	15	15	10	10
Max.output level	dB μ V	100	100	100	100	104
Noise figure typ.	dB	5	4	4	5	5
Max power consumption	mA	100@12VDC	130@12VDC	130@12VDC	130@12VDC	100@12VDC

QPSK-COFDM FTA transmodulator

All in one solution to receive all programs contained in a DVB-S transponder and create a DTT mux in the VHF or UHF band.

- Dynamic bit rate measurement for each program of the selected transponder and for the generated output COFDM multiplex
- Management and settings of all COFDM parameters
- ARP: automatic recovery procedure to protect the higher priority programs and guarantee continuity of service if bit rate overflow occurs
- Priority management of the programs included in the output multiplex
- LCN settings to adjust the channel number order in all TV sets connected to the headend



KSTT

Item		KSTT
Code		270641
Satellite front-end		
Input frequency	MHz	950-2150
Bandwidth	MHz	36
Input level	dB μ V	48-85
Input step tuning	MHz	1
LNB control		0/14/18VDC, 0/22KHz, DiSEqC 1.0
Demodulation		QPSK (DVB-S)
FEC		1/2, 2/3, 3/4, 5/6, 7/8, AUTO
Symbol rate	Msymb/sec	2 - 40
AFC range	MHz	-3 to +3
Loop-through input loss	dB	2.5
COFDM modulation		
Transmission standard		DVB-T
Bandwidth	MHz	6, 7, 8
Carriers		2k, 8k
Modulation		QPSK, 16-QAM, 64-QAM
Guard interval		1/4, 1/8, 1/16, 1/32
FEC		1/2, 2/3, 3/4, 5/6, 7/8
RF output		
Output frequency	MHz	111-862
Output channels		S2-E69
Max. output level	dB μ V	85
Output level adjustment	dB	0-15
RF mix input	MHz	47-862
Output step tuning	KHz	10
RF insertion loss	dB	1
Flatness	dB	1
Output MER	dB	36
Spurious rejection	dB	>50
General Features		
Supply voltage	V	12
Max. Current absorption	mA	600 (without LNB), 1000 (with LNB)
Dimensions	mm	40x200x155
Connectors	Type	F female
Programming unit		TPE
Compliant		EN50083-2, EN60065, EN50221, ETSI TS101699
Operating temperature	°C	-10 to +55

Headends

Digital QPSK receiver with fullband DSB modulator

Free-to-air digital satellite receiver equipped with DSB multistandard analogue modulator to distribute signals to all TV's within the installation. Possible to receive SCPC programs. Automatic PID updating.

- VHF output band modulator (E5-S38) + UHF (E21-E69)
- LNB power supply



KDF

Item	KDF	
Code	282646	
SAT QPSK input		
Input frequency	MHz	950-2150
Input level	dB μ V	45-80
Impedance	Ohm	75
Bandwidth	MHz	36
Input step tuning	MHz	1
AFC range	MHz	-2.5 to 2.5
Loop-through gain	dB	-4 to +4
Max. no. of modules possible to loop-through	Depends on the frequency and the level of the input signal	
LNB power supply	0/12V, 0/22KHz, DiSeqC 1.0 (4 positions), max. 250mA	
QPSK demodulation		
Symbol rate	Msymbol/sec	2 - 35 (compatible SCPC/MCPC)
FEC	Auto	
MPEG specification		
Video decoder	MPEG-2 Main profile, Main level (MP @ ML)	
Audio decoder	MPEG-2 Layer I and Layer II	
Colour standard	PAL, SECAM, NTSC	
Video format	16:9, pan scan, letter box	
Audio format	Mono, language 1, language 2	
TV modulator		
Modulator	DSB (double sideband)	
Standard	PAL (B/G, D/K, I, N, H, M), SECAM L, NTSC M	
Output frequency	MHz	174-446 + 470-862
Channels	E5-S38 + E21-E21-E69	
Output level	dB μ V	90
Output level adjustment	dB	15 by means of trimmer
Audio level adjustment	dB	0-10
S/N weighted	dB	52
Output channel programming	By frequency (steps of 250KHz) or by channel	
No. of outputs	2 outputs (output and mix input)	
TV mixing input	MHz	47-862
TV mixing insertion loss	dB	<2
Test signal	MHz	Black screen or white rows. With radio signal distribution, a picture with the radio name is shown
General features		
Connectors	F	
Programming unit	TPE	
Power supply	VDC	12
Consumption	mA	500 (Without LNB), 850 (with LNB)
Compliant	EN 50083-2	
Dimensions	mm	74x36x58
Operating temperature	°C	-10 to +55
Connectors	Type	F female
Programming unit	TPE	
Compliant	EN50083-2, EN60065, EN50221, ETSI TS101699	
Operating temperature	°C	-10 to +55

QPSK receivers with fullband vestigial sideband modulator

Digital processors for the reception of free-to-air satellite programs transmitted with QPSK modulation.

The fullband modulator covers the whole 47-862MHz band allowing the distribution of adjacent channels. Ideal for use in condominium and hotel headends where it is necessary to distribute the signal to a high number of sockets.

- Vestigial sideband modulator allows adjacent channel distribution
- LNB power supply, 14/18V 0/22KHz, DiSEqC 1.0
- RCA connectors with audio/video signal available on all versions
- Subtitle and teletext management
- WSS signals compatible for the auto-adjustment of TV video formats



KDSR

Item	KDSR	KDSR-S	KDSR-M
Code	270624	270623	270622
SAT QPSK input			
Input frequency	MHz	950-2150	
Input level	dB μ V	43-84	
Impedance	Ohm	75	
Bandwidth	MHz	36	
Input step tuning	MHz	1	
AFC range	MHz	\pm 3	
Loop-through gain	dB	-4 to 0	
Max. no. of modules possible to loop-through		Depends on the frequency and the level of the input signal	
LNB power supply		0/14/18VDC, 0/22KHz, max. 200mA@14VDC - DiSEqC 1.0	
QPSK demodulation			
Symbol rate	M symb/sec	2-45	
FEC		1/2,2/3,3/4,5/6,7/8, auto	
MPEG specification			
Video decoder		MPEG-2 Main profile, Main level (MP @ ML)	
Audio decoder		MPEG-2 Layer I and Layer II	
Colour standard	PAL	PAL	PAL, SECAM, NTSC
Video format		Letter box, pan scan, combined, adapted 16:9	
Audio format	Mono, language 1, language 2	Mono, stereo, dual sound	Mono, language 1, language 2
Teletext		Yes	
RCA outputs			
Video type		Composite	
Video level	Vpp-0hm	1-75	
Max. audio level	Vrms-k0hm	0.5-10	
Band frequency	Hz	20-15000	
TV modulator			
Modulator	VSB mono	VSB stereo	VSB multistandard
Standard	PAL B/G	PAL B/G	D/K, I, N, H, SECAM L, NTSC M
Output frequency	MHz	47-862	
Channels		E2-E69	
Output level	dB μ V	90	
Output level adjustment	dB	0-15 by means of TPE	
Audio level adjustment		Yes	
S/N weighted	dB	\geq 57	
Output channel programming		By frequency (steps of 250KHz) or by channel	
No. of outputs		2 outputs (output and mix input)	
TV mixing input	MHz	47-862	
TV mixing insertion loss	dB	<1.5	
Test signal		Black screen or white rows to be used for radio signal distribution	
General features			
Input connectors		2 F connectors (input + loop through)	
Output connectors		2 F connectors (output and mix input)	
A/V connectors		3 x RCA	
Programming unit		TPE	
Power supply	VDC	12 \pm 5%	
Consumption	mA	With LNB: 1010, without LNB: 730	With LNB: 1060, without LNB: 780
Compliant		EN 50083-2	
Dimensions	mm	40x200x155	
Operating temperature	$^{\circ}$ C	-10 to +45	

Headends

COFDM receivers with fullband vestigial sideband modulator

DTT processors for the reception of free-to-air programs transmitted with COFDM modulation.

The fullband modulator covers the whole 47-862MHz band allowing the distribution of adjacent channels. Ideal for use in condominium and hotel headends where it is necessary to distribute the signal to a high number of sockets.

- Wideband modulator distributes signals from 47 to 862MHz
- Vestigial sideband modulator allows adjacent channel distribution
- RCA connectors with audio/video signal available on all versions
- Subtitle and teletext management
- WSS signals compatible for the auto adjustment of the TV video formats



KDTR

Item	KDTR	
Code	270619	
TV COFDM input		
Input frequency	MHz	174-230 + 470-862
Input level	dB μ V	35-80
Impedance	Ohm	75
Bandwidth	MHz	7 or 8
Input step tuning	KHz	166.7
AFC range	KHz	\pm 285 (2K) \pm 142 (8K)
Loop-through gain	dB	-1.5 to +4
Max. no. of modules possible to loop-through	Depends on the frequency and the level of the input signal	
COFDM demodulation		
Carriers	2K, 8K	
Modulation	QPSK, 16QAM, 64QAM	
Hierarchy	High/low priority	
Guard interval	1/4, 1/8, 1/16, 1/32	
FEC	1/2, 2/3, 3/4, 5/6, 7/8, auto	
MPEG specification		
Video decoder	MPEG-2 Main profile, Main level (MP @ ML)	
Audio decoder	MPEG-2 Layer I and Layer II	
Colour standard	PAL	
Video format	Letter box, pan scan, combined, adapted 16:9	
Audio format	Mono, language 1, language 2	
Teletext	Yes	
RCA outputs		
Video type	Composite	
Video level	Vpp-Ohm	1-75
Max. audio level	Vrms-kOhm	0.5-10
Band frequency	Hz	20-15000
TV modulator		
Modulator	VSB mono	
Standard	PAL B/G	
Output frequency	MHz	47-862
Channels	E2-E69	
Output level	dB μ V	90
Output level adjustment	dB	0-15 by means of TPE
Audio level adjustment	Yes	
S/N weighted	dB	\geq 57
Output channel programming	By frequency (steps of 250KHz) or by channel	
No. of outputs	2 outputs (output and mix input)	
TV mixing input	MHz	47-862
TV mixing insertion loss	dB	<1.5
Test signal	Black screen or white rows to be used for radio signal distribution	
General features		
Input connectors	2 F connectors (output + loop through)	
Output connectors	2 F connectors (output and mix input)	
A/V connectors	3 x RCA	
Programming unit	TPE	
Power supply	VDC	12 \pm 5%
Consumption	mA	670
Compliant	EN 50083-2	
Dimensions	mm	40x200x155
Operating temperature	$^{\circ}$ C	-10 to +45

Agile channel processor

Fully agile RF channel processor to process and convert terrestrial digital and analogue channels.

Due to the high selectivity, it can also be used as a filter. AGC (automatic gain control) facility to maintain a constant output level regardless of the fluctuation of the input signal.

- Dual conversion technology and dual SAW filter to distribute adjacent channels and avoid spurious signals in the band
- Single product to convert a channel within 47-862MHz
- Perfect management when conversion of either adjacent digital or strongly unequalised channels is required
- Wide dynamic input range to guarantee good reception of programs even when signals are weak
- Mixing output to combine the output signal from other K Series modules with very low insertion loss (<1dB in the whole RF band)



KCPN

Item	KCPN	
Code	282618	
Input		
TV Standard Digital	DVB-T - DVB-C	
TV standard Analogue	PAL B/G/1/L/D/K	
Input frequency	MHz	47-862
Bandwidth	MHz	7-8
Input level Digital	dB μ V	45-80
Input level Analogue	55-90	
TV mixing input	MHz	5-862
TV mixing insertion loss	dB	<1
Loop-through input gain	dB	1
Input step tuning	KHz	125
Output		
Output frequency	MHz	47-862
Max. output level Digital	dB μ V	85
Max. output level Analogue	dB μ V	92
Output level adjustment	dB	0-15
General features		
Noise figure	dB	5
Phase noise	dBc/KHz	-85@10
Power supply	VDC	12
Consumption	mA	Max. 500
Dimensions	mm	40x200x155mm
Connectors	Type	F female
Operating temperature	°C	-10 to +55
Compliant	EN50083-2:2008-03	

Headends

Analogue fullband modulators

Audio video analogue modulators.
Three versions are available:

- Single side band twin modulator (PAL B/G MONO)
- PAL B/G stereo vestigial side band single modulator
- Multistandard vestigial side band modulator
- High output C/N
- Audio and video input adjustment using a trimmer



KMTW



KMS

Item		KMTW	KMS	KMM	
Code		270633	270631	270632	
Input					
Input	No.	TWIN	SINGLE	SINGLE	
Video input	Impedance	Ohm	75		
	Input level (adj)	Vpp	1 (0,7-1,2)		
Audio Input	Impedance	KOhm	10		
	Input level (adj)	Vrms	0,5 (0,5-2,5)		
Standard		PAL B/G mono	PAL B/G stereo	Multistandard N, H, D, K, I, L	
Audio carrier frequency	B/G mono	MHz	5,5	-	
	B/G stereo		-	-	
	Left carrier	MHz	-	5,5	
	Right carrier	MHz	-	5,74	
	L, D/H	MHz	-	-	6,5
	I	MHz	-	-	6
	N	MHz	-	-	4,5
Audio-Video power carrier ratio	N	dB	-	-	10
	H	dB	-	-	14
	I	dB	-	-	14
	D/K	dB	-	-	13
	L	dB	-	-	8
	B/G mono	dB	14	-	-
	B/G stereo	dB		14 (left c.) 21 (right c.)	
Modulation with audio input 1kHz, 0,5Vrms	B/G	KHz	49	49	-
	N (FM)	KHz	-	-	<42
	H	KHz	-	-	44
	I, D/K (FM)	KHz	-	-	>47
	L (AM)	KHz	-	-	80%
Modulation depth for 1Vpp video input	D/K, I, B/G			80% typ.	
	L		-	-	90-97%
Output					
Generated channel	No.	2	1	1	
Output frequency (channels)	MHz	47-862 (E5-E69)			
Output channel programming	By frequency (steps of 250KHz) or by channel				
Channel standard	B/G Europe		PAL I, B/G Europe, L France, B Australia, NTSC M		
Max. output level	dBμV	90			
Output level adjustment	dB	0 - 15 by means of TPE			
Insertion loss	dB	<1,5			
C/N on channel	dB	>57			
Spurious rejection	dB	< -57			
General features					
Output	No.	2 F connectors (output + mix input)			
Mains voltage	VDC	12	12	12	
Consumption	mA	510	500	400	
Power consumption	W	6,1	6	4,8	
Operating temperature	°C	-10 to +55			
Dimensions	mm	40x200x155			
Compliant		EN 50083-2			

SAT amplifiers + TV mixer

Amplifies satellite IF (950-2150MHz) whilst mixing terrestrial TV frequencies of 47-862MHz.

Overcomes the higher losses experienced when distributing SAT IF.

(*) With 12VDC available in the SAT input to power an LNB



KX125

Item		KX125	KX125NT	KX125E (*)
Code		282104	282105	282106
Input frequency	MHz	950-2150 / 47- 862		
Gain 950-2150 MHz (adj.)	dB	38-44 (20)	35 (20)	38-44 (20)
TV loss	dB	-1	-1	-1
SAT Max. output	dBµV	125	125	125
SAT Noise Figure	dB	6	6	6
Max. power consumption	mA	310@12VDC	280@12VDC	310@12VDC
Dimensions	mm	32x129x86		

Transponder amplified selective filter

The KFT module selects and amplifies a DVB-S/S2 transponder between 950 to 2150MHz.

The filter uses K series housing with F connectors and is self-mixing both for input and output.



KFT/..

(**) The desired trasponder must be specified during the order

Item		KFT/.**	KFT/..**	KFT/...**
Code		282614	282615	282616
Input Frequency	MHz	950-1450	1451-1700	1701-2150
Gain (adj.)	dB	18 (20)		
Bandwidth	MHz	33		
Output level	dBµV	100		
Max. power consumption	mA	105@12VDC		
Dimensions	mm	32x129x86		

Programmable IF-IF DVB-S2 converter

Fully agile IF-IF converter that enables the selection of a transponder from 950-2150MHz and converts it to a free position in the same band. Usable as a SAT filter, by setting the same input and output frequency. Fully compliant with DVB-S2, DVB-S and analogue transponders.

- IF-IF converter compatible with DVB-S2 standard, programmable using a TPE
- SAW filtering technology guarantees high quality in conversion and distribution of adjacent transponders
- The converter is provided with AGC to keep the output level constant
- Very low phase noise makes it particularly suitable for HD transponders
- Remote power supply programmed via software



KIF-S2

Item		KIF-S2
Code		282589
Inputs		1 SAT input and 1 loop-through output to other modules
Outputs		1 SAT output and 1 mix-in input to mix the signal coming from other modules
Input and output frequency SAT	MHz	950 - 2150
Supported SAT Standard		Digital: DVB-S QPSK
		Digital: DVB-S2 QPSK 8PSK
		Analogue: FM
Input level	dBµV	55-90
Max. output level	dBµV	90
Output level adjustment	dB	0-15
Bandwidth	MHz	36 or 27
Loop-through insertion loss	dB	<1
Mix in insertion loss	dB	<1
Return loss	dB	>10
LNB power supply	VDC - mA	12 - 250 max. - programmable via TPE
General features		
Connectors	Type	F female
Mains voltage	VDC	12
Operating temperature	°C	-10 to +55
Consumption	mA	300 (550 when LNB power supply is set)
Dimensions	mm	32x129x86
Operating temperature	°C	-10 to +55

Headends

TV push-pull final amplifiers

Broadband launch amplifier with push-pull technology allows the amplification of the whole 47-862MHz band, including the S band. With one input and one output, the KW series are used to amplify the signal from KF filters or other modules (receivers, modulators, etc). The KW35E passes the return channel (5-30MHz).



KW44C

KW20D



KW35D

KW35E

Item		KW33B	KW33C	KW44C	KW20D	KW35D	KW35E
Code		270050	270053	270051	270049	270061	270059
Frequency range	MHz			47-862			5-30 47-862
Gain (adj)	dB	34 (20)	32 (20)	44 (20)	20 (20)	35 (20)	35 (20)
Slope adjustment	dB		-		0-20		
Max. output level	dB μ V	116	120	120	120	125	129
Noise figure typical	dB	8	9	8	6	5	6
Max. power consumption (@12 Vdc)	mA	300	510		550	640	830
Dimensions	mm	32x129x86			63x184x107		

Power supplies

The power supply units contain switching technology to ensure the best performance and reliability. They are protected from both short and long term overloads.



KP15



KP35

KP62

Item		KP15	KP35	KP62
Code		270018	270017	270019
Mains voltage	Vac, Hz		220-240, 50-60	
Power consumption	W	23	55	87
Output voltage	V		12	
Max. current	A	1.5	3.5	6.2
Operating temperature	°C.		-10 to +55	
Isolation			class II	
Dimensions	mm	40x130x86		63x165x107

Programming Unit

Enables the programming of all new K Series modules, DIGIFLEX, Headline range and also the original K Series modules.

- USB drivers available for PC connection
- Language menu available: Italian, English, German, French, Spanish and Portuguese
- Max. addressable modules: 253
- Copy function available, to copy the settings from one device to another
- Adjustable contrast (31 steps)
- Display: LCD graphic backlit display, 16x4 characters
- 18 button keypad



Item	code	Description	Packaging (Pcs)
TPE	282733	Programming unit with numeric keypad and graphic display.	1
KRS-RJ	282732	USB-RJ45 adapter (Compact Line, K Series, Digiflex, Headline) necessary to connect the module to the PC.	1

Accessories

Plug-in “F” bridges

These are shielded quick push on connectors. For connections between an active splitter and receiver modules as well as between the active splitter and self-mixing line of the output signal.



Item	code	Length (mm)	Compatible with	Packaging (Pcs)
KRF15	289537	150	KDTR, KDSR, KCPN, KM, KDF, KSTT	20
KRF16A	280009	160	KDSR, KCPN, KM, KDF, KSTT	20
KRF32A	280010	320	KDSR, KCPN, KM, KDF, KSTT	10
KRF45	289538	450	KW and KX125, KSTT	10
KPR37	289485	37	KF, K120L, K120A, KIF-S2, KFT, KFB4, KFB5, KFBU, KFB3	20
KPR41	289486	41	Headline modules, KF, K120L, K120A, KIF-S2, KFT, KFB4, KFB5, KFBU, KFB3	20
KPR52	289491	52	KDTR, KDSR, KCPN, KSTT	20

Shielded quick push “F” bridges

These are shielded quick push on connectors. For connecting modules.



Headends

Accessories

Shielded twiston bridges

These are shielded twist on connectors. For connecting modules.



KPN..



KD100N



MPCCF

Item	code	Length (mm)	Compatible with	Packaging (Pcs)
KPN51	289244	51	KDTR, KDSR, KCPN, KSTT	10
KD100N	270002	DIN BAR (35x15x1.5mm) galvanised. Length 1m, used for installing K series modules.		2
CVDC50	280376	12V cable feed, Length 50 cm		1
MPCCF	236508	D.C Inserter for supplyng D.C. to pre-amplifiers. With plug, socket and 20cm lead for D.C. Ø 2.3mm. With F connector.		-

Broadband pre-amplifiers

To be used to increase weak signals before entering a KF amplifier or K120 filter. As they are easy to connect, they are particularly suitable for use with the MBX and K series. Metal housing. 1 transistor. V.S.W.R. < 2. With socket and 30cm cable with D.C. plug. Input R.F. only. Powered via output connector or D.C. plug.



MP45AF

Item	MP45AF
Code	236507
Band inputs	UHF
Gain	15 dB
Noise figure	4 dB
Max. output level	108 dB μ V
Bandwidth	470-862 MHz
Max. power consumption	20 mA
Loop-through input gain	1 dB

High Level Headends

Headline series

The design targets of the Headline Series are:

- 19" rack mounting for professional installation
- Flexibility in headend composition, easy integration of different modules
- Constant operation of the installation, the hot insertion of modules allows modules to be added or changed without switching off the whole headend
- Easy maintenance, programming the modules is possible from any interconnection module or remotely via PC
- Efficiency, each single module has its own power supply, no need for power supply redundancy to ensure the correct functionality of the headend

The basic system is composed of an interconnection module in a frame with a range of further modules and a programming unit. The modules are installed in a pre-mounted 19" subrack to be fitted into a 19" rack cabinet. The programming unit is linked to one interconnection module and enables all the modules installed in the headend to be programmed. A remote programming unit is available.

The main features of Headline series product are:

- Complete range of products equipped with different technological solutions: analogue and digital modulators, IP encoders and fibre optic modules
- Easy integration of different modules
- 220V mains voltage distributed to all the modules through the interconnection module
- All the connectors are located on the front panel

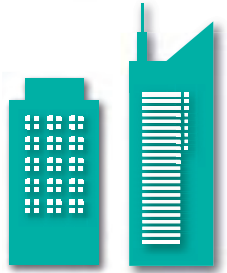

Headline Headend

Installation Example - SAF-HD

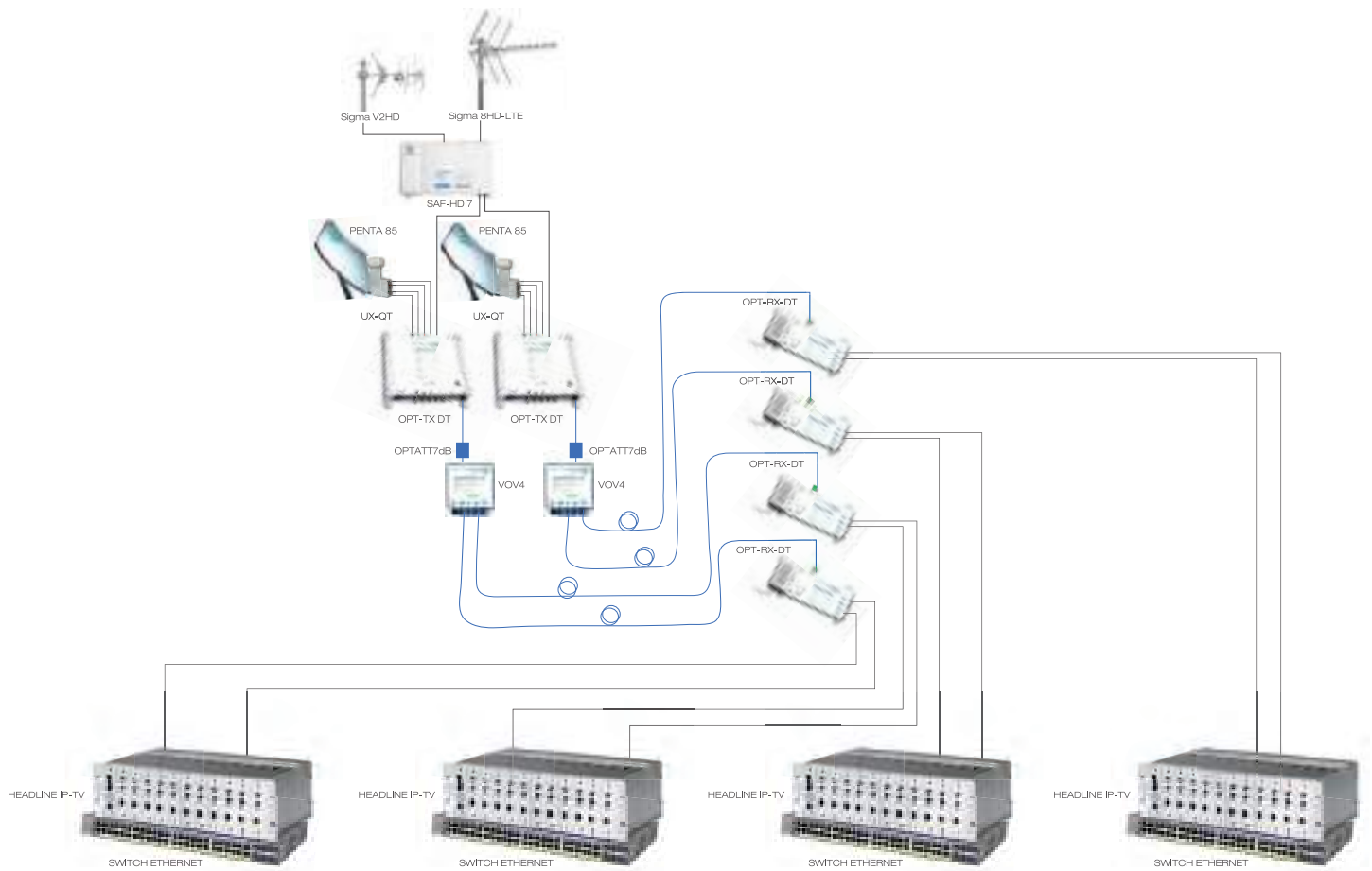

Headends

COFDM receivers

COFDM receivers to distribute a free-to-air (SIG7531) or encrypted (SIG7540) signal from a terrestrial digital source (DVB-T).

In a typical application they can be connected to an SIG7120 module (modulator) that uses the TS flow to create a COFDM multiplex.

They can also be connected to an IP encoder SIG7720 creating multiple IP multicast streams. They can also be installed as a single unit to distribute one program through RCA outputs (for MPEG-2 compressed programs).

- Ideal solutions for regeneration of DTT signals
- Enables the audio/video signal to be available as a TS MPEG2/MPEG4 distributed from the back panel
- Loop-through input for the connection of several receivers on the same SAT polarity
- Remote configuration and monitoring (via SIG7905 controller host and FHM software)
- HD compliant



SIG7531



SIG7540

Item	SIG7531	SIG7540		
Code	283952	283951		
Terrestrial COFDM input	Bandwidth	MHz	174 - 230, 470 - 862	
	Minimum frequency step tuning	KHz	167	
	Channel bandwidth	MHz	7, 8	
	Loop-through bandwidth	MHz	47-862	
	Loop-through insertion loss	dB	-3 to 2	1
	Input level	dB μ V	35-80	
	AFC	KHz	\pm 285 (2k), \pm 142 (8k)	
	Symbol rate	Msymb/sec	2-30	
	Max. no. of modules possible to loop-through	Depends on the frequency and the level of the input signal		
	COFDM demodulation	Carrier	2k, 8k	
Guard Interval		1/4, 1/8, 1/16, 1/32		
Modulation		QPSK, 16QAM, 64QAM		
Hierarchy		High/low priority		
FEC		1/2, 2/3, 3/4, 5/6, 7/8, auto		
Common Interface	Connector	-	PCMCIA	
	Standard	-	Interface standard EN50221, TS101699	
MPEG decodification	Video decoder	MPEG-2 ML@MP		
	Audio decoder	MPEG-2 Layer I and II		
	Video standard	PAL, PAL-N, SECAM-L, NTSC-M, PAL-M		
	Video format	Adapted 16/9, letter box, pan scan, combined		
	Audio format	Mono, mono lang. 1, mono lang. 2, stereo		
RCA outputs	Output connector	RCA female		
	Audio level	mVrms	550 max.	
	Video level	Vpp - Ohm	1 typical - 75	
	SINAD	dB	45	
TS outputs	Connectors	48 pins on the back panel		
	Type	Parallel		
General features	Mains voltage	Vac, Hz	220-240-, 50-60	
	Power consumption	W	4.5	7 (with CAM)
	Compliant	EN60065: 2004-06, EN50083-2: 2002-05		
	Dimensions (rack version)	mm	35.5 (7e) x 133.3 (3U) x 240	
	Operating temperature	°C	-10 to +45	

SAT receivers

The SIG7330 QPSK receivers with audio/video outputs on RCA (cinch) connectors to receive free-to-air digital satellite programs. The SIG7330 module has also a TS output on the back panel. One input and one loop-through output for the connection of several receivers on the same SAT polarity.

The SIG7340 QPSK receivers with Common Interface slot to receive free-to-air or encrypted digital satellite programs available on audio/video outputs with RCA (cinch) connectors. The SIG7340 module has also a TS output on the back panel. Loop-through output for the connection of several receivers on the same SAT polarity. The SIG7100 module, with its Common interface, distributes an encrypted or free-to-air digital signal from satellite in DVB-S or DVB-S2 standard. It can be installed as a standalone unit to distribute one program through the RCA outputs or it can be connected to an SIG7120 module (COFDM modulator) or SIG728x modules (analogue modulators).

When connected to the SIG7120 it enables the distribution of a compressed MPEG-4 channel.

- CI slot available to decode the encrypted programs.
- SIG7340 module can be used as a second CAM card
- They can generate 14 or 18V, 22 KHz tone and DiSEqC 1.0, suitable to power LNB or to control multiswitch output
- Programmable via FHM software
- Ideal for the reception of High Definition (HD) programs (SIG7100)



SIG7100



SIG7340

Item		SIG7330	SIG7340	SIG7100
Code		283954	283955	283949
SAT input	Input frequency	MHz	950-2150	
	Input level	dBµV	48-85	
	Impedance	Ohm	75	
	Standard		DVB-S	DVB-S, DVB-S2
	Input step tuning	MHz		1
	AFC range	MHz		±5
	Loop-through insertion loss	dB		2
	Max. no. of modules possible to loop-through		Depends on the frequency and the level of the input signal	
	LNB power supply		0/14/18VDC, max. 0-22KHz max. 200mA@14VDC DiSEqC 4 pos	
Demodulation	Symbol rate	M symb/sec	2-40 (DVB-S)	2-40 (DVB-S), 2-30 (DVB-S2)
	FEC		1/2,2/3,3/4,5/6,7/8, auto	
Common Interface	connector	-	PCMCIA	
	standard	-	EN50221, TS101699	
Audio /video outputs	Video decoder		MPEG-2 Main profile, Main level (MP @ ML)	
	Audio decoder		MPEG-2 Layer I and Layer II	
	TV standard encoder		PAL, PAL-N, PAL-M, SECAM-L, NTSC-M	
	Video format		Adapted 16/9, letter box, pan scan, combined	
	Audio format		Mono, mono language 1, mono language 2, stereo	
	Teletext		Yes	
RCA outputs	Video		Composite	
	Video output level	Vpp - Ohm	1-75	
	S/N video weighted	dB	45	
	Max. audio level	KOhm - VRMS	10 - 0.5	
	Audio band frequency	Hz	20-15000	
	S/N audio weighted	dB	>60	
TS outputs	Connectors		48 pins on the back panel	
	Type		Parallel	
General features	Input connectors		2 F connectors (SAT IN+DC, SAT OUT loop-through)	
	A/V connectors		3 x RCA	
	Programming interface		TPE	
	Mains voltage	Vac, Hz	220-240, 50-60 (by means of SIG7901 or SIG7902)	
	Power consumption	W	11	
	Compliant		EN60065: 2004-06, EN50083-2: 2002-05	
	Dimensions (rack version)	mm	133.3 (7e) x 35.5 (3U) x 240	
	Operating temperature	°C	-10 to +45	

Headends

Analog modulators

Audio video modulators, double conversion, double saw filter and tracking filter built in. One modulator covers the whole 47-862MHz band and a very high C/N ratio in the band allows the distribution of more than 80 channels. Available in PAL B/G mono (SIG7282), PAL B/G stereo (SIG7282S) and multistandard (SIG7281).

- Fully agile output modulators, with double conversion, saw filter and tracking filter built in. Using only one modulator, the whole 47-862MHz band can be covered, simplifying the installation and maintenance of the system
- High output level, 95dB μ V, to mix all the channels together
- RCA (cinch) connectors for audio and video input, F connectors for RF output
- RCA cable and KPR41 solid bridge are included
- Programmable via FHM software



SIG7282

Item			SIG7282	SIG7282S	SIG7281
Code			283943	283944	283933
Video signal input	Impedance	Ohm		75	
	Level	Vpp		0.7-1.4	
Left and right audio input	Impedance	KOhm		10	
	Nominal input level	Vpp		0.5-3.5	0.5-2
Standard			PAL B/G mono	PAL B/G stereo	D/K, I, L, N, H
			Mono	Mono, stereo, dual sound	Mono
Audio carrier frequency	B/G standard mono or left carrier	MHz	5.50	5.50	-
	Right carrier	MHz	-	5.74	-
	Standard H	MHz	-	-	5.50
	Standard L D/K	MHz	-	-	6.50
	Standard I	MHz	-	-	6.00
	Standard N	MHz	-	-	4.50
Video/audio power carrier ratio	Standard N	dB	-	-	10
	Standard H	dB	-	-	14
	Standard I	dB	-	-	14
	Standard D/K	dB	-	-	13
	Standard L	dB	-	-	8
	Standard B/G: Mono (5.5MHz)	dB	13	13	-
Modulation with audio input 1KHz, 0.5Vrms	Stereo (5.74MHz)	dB	-	20	-
	B/G	KHz	45	45	49
	N (FM)	KHz	-	-	42
	H	KHz	-	-	44
	I, D/K (FM)	KHz	-	-	>47
Output frequency					80%
			MHz	47-862	
Channels				E2-E69	
Output level			dB μ V \pm dB		95 \pm 2
	Level adjustment	dB	15 by steps of 1		
	Loop-through attenuation	dB	< 1.5@860MHz		
	Return loss	dB	>10		
C/N in the channel N \pm 3			dB	>66	
C/N \pm 40MHz			dB	>70	
S/N			dB	>50	
S/N in the channel			dB	50	
S/N with 80 channels			dB	48	
Spurious rejection			dB	>60	
Mains voltage		Vac, Hz	220-240, 50-60		
Power consumption		W	8		
Compliant			EN50083-2, EN60065		
Dimensions (rack version)		mm	35.5 (7e) x 133.3 (3U) x 240		
Operating temperature		$^{\circ}$ C	-10 to +45		

COFDM modulators

The SIG7120 modulates a signal (TS) received in the input from the back panel in COFDM DVB-T standard. The main application is DVB-S2 to COFDM transmodulation, when connected to an SIG7100 module. On the front panel there is an additional F connector for output loop-through feature.

- Possibility to choose the desired COFDM modulation
- Output level adjustment
- High Definition (HD) compliant
- When connected to different receivers (SAT, COFDM, A/V, etc.), different types of transmodulation can be performed
- Programmable via FHM software



SIG7120

The SIG7121 modulates a signal received in the ASI input to DVB-T standard (using COFDM modulation). The external analogue or HDMI sources encoding are the typical applications that could be performed by using the SIG7121 digital modulator in addition to SIG7404H or SIG7802HD

- COFDM modulator with ASI input on the front panel
- Remote configuration and monitoring (via controller host SIG7905 and FHM software)
- High Definition (HD) compliant
- MPEG2/MPEG4 compliant



SIG7121

Item	SIG7120		SIG7121	
Code	283950		283953	
Transport stream input	Connectors	48 pins on the back panel		
	Types	Parallel		
	Max. bit rate	Mbit/s	100	
ASI input	ASI connector	-		BNC, 75 Ohm
	Max. bit rate	Mbit/s	-	216
Output signal	Output connector	F female		
	Output frequency	MHz	108-862	
	Frequency step	KHz	10	
	Max. output level	dB μ V	85 \pm 2	
	MER (typical)	dB	38	
	Level adjustment	dB	0-15 (step 1dB)	
	Loop-through loss	dB	<1.5	
	Carrier	2K, 8K		
	Modulation	QPSK, 16QAM, 64QAM		
	FEC	1/2, 2/3, 3/4, 5/6, 7/8		
	Guard interval	1/4, 1/8, 1/16, 1/32		
	Spectrum	Normal/Inverted		
	General features	Mains voltage	Vac, Hz	220-240, 50-60
Power consumption		W	10	11
Dimensions		mm	35.5 (7e) x 133.3 (3U) x 240	
Operating temperature		°C	-10 to +45	

Headends

Professional encoders

The new SIG7404H 19" standard rack format is a Standard Definition Encoder which encode and remux its four Audio/Video composite input sources on DVB-ASI output interface. The video resolution of the SIG7404H encoder can achieve 576i/480i by using the MPEG2 low latency encoding engine and the standard TS Mux technologies.

- Four A/V analogue Inputs
- WEB interface included in each encoder
- Programmable video and audio parameters: PMT, PCR PIDs, NIT LCN, Service Name
- "Fanless" product: natural convection cooling for reducing maintenance costs.



SIG7404H

The new SIG7802HD 19" standard rack format is a dual HD video inputs digital encoder which encode and remux the input sources on DVB-ASI output interface. The SIG7802HD is designed to achieve 1080i by using MPEG2 low latency encoding engine and standard TS Mux technologies.

- Dual HDMI Inputs
- WEB interface included in each encoder
- Programmable video and audio parameters: PMT, PCR PIDs, NIT LCN, Service Name
- "Fanless" product: natural convection cooling for reducing maintenance costs.



SIG7802HD

Item	SIG7404H		SIG7802HD	
Code	287348		287349	
Input				
No. of inputs	4 x CVBS		2 x HDMI (Type A receptacle)	
Video connector	Type	RCA	compliant with HDMI 1.3a	
Video Impedence	Ohm	75	-	
Audio connector	Type	RCA (Left, Right stereo channels)	HDMI	
Audio Impedence	Kohm	10	-	
Encoding				
Video resolution	576i/480i		Up to 1080i 30Hz	
Video compression	MPEG-2 Video(ISO/IEC 13818-2) MPEG-2 MP@ML		MPEG-2 Video(ISO/IEC 13818-2) MPEG-2 MP@ML-MPEG-2 MP@H-14L	
Audio compression	MPEG-1 Audio Layer II (ISO/IEC 11172-3)		MPEG-1 Audio Layer II (ISO/IEC 11172-3)	
Audio encoding rate	Kbps	128, 256, 384		
Advanced settings				
PID setting	PMT/Video/Audio/PCR			
TS network configuration	NID/ONID/P.D.S./TS ID			
LCN range settings	Up to 1023			
Service name	at most 15 characters			
ASI Output				
No. of outputs	1 x BNC			
Impedence	Ohm	75		
Standard	DVB-ASI			
Max. output bitrate	Mbps	108		
General features				
Connectors	Type	BNC (ASI Out),RCA (Video and Audio signal), RJ45 (settings through web interface built-in)		BNC (ASI Out), HDMI 1.3a (Video/Audio input signal), RJ45 (settings through web interface built-in)
Mains supply	Vac. Hz	110-240, 50/60		
Typical power consumption	W	25	40	
Mounting	19 inch standard rack mount			
Dimensions (L x H x W)	mm	440 x 44 x 280		
Operating temperature	°C	0 to +45		
Compliant	EN50083-2, EN60065			

IP encoders (FTA)

The encoders work as a DVB-S (SIG7710) and DVB-T (SIG7730) to IP gateway. Satellite and Digital Terrestrial Television signals are received on the F connector input, converted to IP standard signals and streamed through RJ45 output port into LAN. From the user side, the programs and services can be viewed using an IP set top box (STB) on TV devices or using dedicated software on PC.

- Programs and services delivered as multicast or unicast streams
- Loop-through (active/passive) input allows easy management of the headend
- MPEG-2/MPEG-4 compliant
- Programmable via Web Interface or via FHM software



Item	SIG7710		SIG7730		
Code			283945	283946	
Input	Input frequency	MHz	950-2150	174-230, 470-862	
	Input frequency step	MHz	1	-	
	Min. frequency step	KHz	-	166.7	
	AFC	SAT	MHz	±3	-
		2K	KHz	-	±285
		8K	KHz	-	±142
	Loop-through loss	dB	<1.5	<1.5	
	Input level	dBµV	40-84	30-80	
	Return loss	dB	10	-	
	LNB power supply	V, KHz, mA	0/14/18, 0/22, 200	-	
	DiSEqC		1.0	-	
	Demodulation		ETS 300421	-	
	Symbol rate	MSymb/sec	2-35	-	
FEC		1/2, 2/3, 3/4, 5/6, 7/8, auto	-		
TV input signal	Carrier		-	2K, 8K	
	Modulation		-	QPSK, 16QAM, 64QAM	
	Hierarchy		-	High / low priority	
	Timeguard		-	1/4, 1/8, 1/16, 1/32	
	FEC		-	1/2, 2/3, 3/4, 5/6, 7/8, auto	
	Demodulation		-	ETS300744	
	Connectors	Type		F	
Output	LAN Interface		IEEE 802.3 100BaseT		
	Incapsulation		ETSI TS102034		
	Type of streaming		Multicast/Unicast		
	Web services		DVB Encapsulation, http, TELNET, FTP, SAP		
General features	Mains voltage	Vac, Hz	220-240-, 50-60		
	Consumption	W	11	4	
	Dimensions (rack version)	mm	35.5 (7e) x 133.3 (3U) x 240		
	Operating temperature	°C	-10 to +45		

IP encoder from TS

The SIG7720 encoder works from Transport Stream (TS) to IP gateway. Signals are received from the back-panel, converted to IP standard signals and streamed through RJ45 output port into LAN. Input signal can be received from either SIG7100 module (DVB-S2 to TS) or SIG7540 module (DVB-T to TS).

- Programs and services delivered as multicast or unicast streams
- Loop-through (active/passive) input allows easy management of the headend
- MPEG-2/MPEG-4 compliant
- Programmable via Web Interface or via FHM software



Item	SIG7720		
Code	283947		
Input	Connector	Type	48 pins on the back pane
	Max. bit rate	Mbit/s	100
Output	LAN interface		IEEE 802.3 100BaseT
	Incapsulation		ETSI TS102034
	Type of streaming		Multicast/Unicast
	Web services		DVB Encapsulation, http, TELNET, FTP, SAP
General features	Mains voltage	Vac, Hz	220-240, 50-60
	Power consumption	W	8
	Dimensions (rack version)	mm	35.5(7e) x 133.3 (3U) x 240
	Operating temperature	°C	-10 to +45

Headends

Optical transmitter

Optical transmitter that converts an RF TV-SAT signal into an optical signal. The signals are transmitted at 1310nm with optical power of 13mW.

This high powered signal can be split up to 16 times.

Five different LEDs show you the module status - module on, laser on, over current, laser temperature and board temperature.

- High optical power
- High Definition (HD) compliant
- Very high S/N
- Programmable via FHM software
- Can be remotely controlled



SIG7600-HTX

Item	SIG7400	
Code	270678	
Optical wavelength	nm	1310
Optical output power	mW (dBm)	13 (11.1)
Optical return loss	dB	> 55
RF bandwidth	MHz	47-2150
Flatness TV (47-862MHz)	dB	±1
Flatness SAT (950-2150MHz)	dB	±2
Link flatness (47-2150MHz)	dB	±2.5
RF input level	dBµV	80-85 (opt. 85)
RF return loss	dB	>10
Input impedance	Ohm	75
RF connector	F female	
Optical connector	SC/APC	
Mains voltage	Vac, Hz	220-240, 50-60
Power consumption	W	4
Dimensions (rack version)	mm	35.5 (7e) x 133.3 (3U) x 240
Operating temperature	°C	-10 to +45

Optical splitters

Optical splitters that split the optical signal into two outputs (SIG7622) and four outputs (SIG7624).

The optical signal on all the outputs depends only on the typical insertion loss.

- Optimised insertion loss
- High Definition (HD) compliant
- Professional rack solution



SIG7622

SIG7624

Item	SIG7622	SIG7624
Code	270687	270688
Wave length	nm	1310, 1550
No. of outputs	2	4
Insertion loss	dB	3.2
Return loss	dB	>50
Isolation	dB	>50
Connectors	Type	SC/APC
Dimensions (rack version)	mm	35.5 (7e) x 133.3 (3U) x 240
Operating temperature	°C	-10 to +45

Interconnection module

Interconnection module to power and address the headline modules. The interconnection module is installed in sub-rack SIG7901 or SIG7902. Allows the distribution of mains voltage to power all modules installed in the same row. It also distributes the data bus to address and control the modules.



SIG7900

Item	SIG7900		
Code	283935		
Mains voltage	Vac, Hz	220-240, 50-60, class II	
Power consumption	W max.	2 (stand alone) 100 (with all the modules connected)	
Back panel connections	Mains voltage, RS485, address line		
Compliant	EN50083-1, EN50083-2, EN60065		
Dimensions (rack version)	mm	35.5 (7e) x 133.3 (3U) x 240	
Operating temperature	°C	-10 to +45	

Sub rack and accessories



SIG7901



SIG7903



SIG7904

Item	code	Description	Pcs
SIG7901	283930	19" HEADLine sub rack + interconnection module SIG7900 included (11 slots available). The SIG7901 is fully mounted, with all the accessories included in the packaging (mains cord, extracting tools, channel labels and module labels).	1
SIG7903	283928	Spacer kit to allow the 19" subrack SIG7901 to be mounted further back than the other equipment in the 19" rack cabinet.	1
SIG7904	283927	Front plate, 3U 1 slot, to be used with SIG7901 to cover empty bays.	5

Headends

Accessories

TPE programming unit

Enables the programming of all new K Series modules, DIGIFLEX, Headline range and also the original K Series modules.

- USB drivers available for PC connection
- Language menu available: Italian, English, German, French, Spanish and Portuguese
- Max. addressable modules: 253
- Copy function available, to copy the settings from one device to another
- Adjustable contrast (31 steps)
- Display: LCD graphic backlit display, 16x4 characters
- 18 button keypad



TPE



FHM



KRS-RJ

Management Software and USB-RJ45 adapter suitable for K Series, SAF, SIG9708CI, HEADLine



CV-RCA/HQ

Item	code	Description	Pcs
TPE	282733	Programming unit with numeric keypad and graphic display.	1
FHM	289888	<ul style="list-style-type: none"> ■ Using FHM the critical parameters of connected modules can be viewed locally or remotely ■ For user defined parameters an upper and lower alarm limit can be set 	1
KRS-RJ	282732	USB-RJ45 adapter (Compact Line, K Series, Digiflex, Headline) necessary to connect the module to the PC	1
CV-RCA/HQ	289852	1High quality A/V cable with 3 RCA connectors 27.5cm in length, 38.5cm in length with 3 connectors	1

19" rack cabinets

The range includes two floor standing cabinets and one wall mounted cabinet, with accessories, to be used to install SMATV headends for K Series and Headline. The cabinets and accessories are available on request with a delivery time of 20 days from order. All the products are packaged individually. The height of the 19" rack is given in U, one U equals 44.45mm. The width is given in e, one e equals 5.08mm. One cabinet can contain 84e, equal to 42.6cm (the space needed to install the equipment with a width of 19" is 48.26cm). One inch equals 2.54cm.



19" rack accessories



Item	code	Description	Pcs
RACK42U	289722	19" floor standing cabinet. Tempered glazed door. All side and rear cabinet panels can be disassembled for easy installation of equipment. The 19" uprights are adjustable according to the depth of the equipment to be installed. Two apertures for feeding cables into the unit at floor level or at the top where a ventilation kit can be fitted. The cabinets are supplied pre mounted. Dimensions mm (wxdxh): 600x400x1957 - Width: 84e - Max. depth : 320mm - Height: 42U	1
RACK27U	289721	19" floor standing cabinet. Tempered glazed door. All side and rear cabinet panels can be disassembled for easy installation of equipment. The 19" uprights are adjustable according to the depth of the equipment to be installed. Two apertures for feeding cables into the unit at floor level or at the top where a ventilation kit can be fitted. The cabinets are supplied pre mounted. Dimensions mm (wxdxh): 600x400x1290 - Width: 84e - Max. depth: 320mm - Height: 27U	1
RACK6U	289720	19" wall mounted cabinet. Tempered glazed door that can be rotated 180°. The 19" uprights are adjustable according to the depth of the equipment to be installed. Two apertures for power cables at floor level or at the top where a ventilation kit can be fitted. Dimensions mm (wxdxh): 550x320x310 - Width: 84e - Depth: 280mm - Height: 6U	1
RACK01	289708	Set of 50 M6 cage nuts and 50 screws.	1
RACK02	289709	Set of 4 levelling feet	1
RACK03	289710	Set of 4 wheels (two with brakes)	1
RACK04	289711	1U cable inlet panel	1

Headends



RACK05 289712 3U blank panel 1

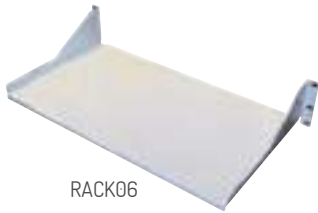

RACK06 289713 19" shelf - 250mm 1



RACK07 289714 1U blank panel 1



RACK08 289715 2U, 150mm recessed panel 1



RACK09 289716 4U, 150mm recessed panel 1



RACK10 289717 2 fan units with steel grid. Recommended for RACK27U 1



RACK11 289718 3 fan units with steel grid and thermostat. Recommended for RACK42U 1



RACK12 289719 Power duct with 5 universal sockets with magneto-thermal switch (4.5kA) 1

Fibre optic solutions

Home Fibre

OPT-TX transmitter	100
WDM diplexer	101
OPT-RX receivers	101
VOV series splitters	102
VOT series taps	102
Home Fibre accessories	102

Fibre optic

OPT series	103
K series	103

Fibre optic solutions

K series	104
Headline series	104
Accessories	104

Fibre optic

Home Fibre



OPT- TX transmitters

- Installation using a standard LNB and dish
- AGC on transmitters enables the use of several different diameter dishes
- Cascadable solution similar to MSW distribution
- Up to 21dB optical distribution loss
- Quick and easy to install
- Complete terrestrial bandwidth

Item		OPT TX-DT	OPT TX-1510	OPT TX-1530	OPT TX-1550	OPT TX-1570
Code		270694	270667	270668	270669	270670
RF inputs	No.			5 (4 SAT + 1 TERR)		
RF outputs	No.			7 (4 SAT + 1 TERR + 2 TEST)		
Optical output	No.			1 SC/APC		
SAT Inputs						
Bandwidth	MHz			950 - 2150		
Connectors				F Female		
Input return loss	dB			10		
Trunk insertion loss	dB			<2		
Input level	dBuV			69 - 86		
TV Input						
Bandwidth	MHz			87 - 862		
Connectors				F Female		
Input return loss	dB			10		
Trunk insertion loss	dB			1		
DVB-T input level	dBuV			80 @10 ch		
Test Output						
Bandwidth	MHz			87 to 862/950 to 2150		
Connectors				F Female		
Input return loss	dB			10		
Test connector attenuation	dBuV			59 each channel		
Optical Output						
Connectors				SC/APC		
Wavelength		1310	1510	1530	1550	1570
Optical power	dBm	7,5	6,5	6,5	6,5	6,5
Optical return loss	dBuV			>45		
Safety class				1M		
Main Features						
Mains	Vac/Hz			184 - 264/50 - 60		
Power consumption	W			15		
Remote LNB powering	mA			200 @ 14V (4 SAT connectors)		
Operating temperature	°C			-5 to +55		
AGC dynamics laser modulation	dB			20		
LED	dBuV			Green power on Red laser extra current		
Standard conformity				CEI EN 50083-2 EN60065		
Dimensions	mm			230x230x50		

Home Fibre

WDM diplexer

Wavelength color code selection
SC/APC connectors
Solutions for 2 and 5 different waveleght.
Quick and easy to install



CWDM 5 MUX/DEMUX



WDM2

Item		CWDM5 MUX	CWDM5 DEMUX	WDM 2
Code		287341	287342	287343
CWDM center wavelenght	nm	1511 - 1531 - 1551 - 1571		1310 -1550
CWDM passband width 13nm@0.5dB	nm	AC +/- 6.5		AC +/- 20
Channel Spacing	nm	20		
CWDM Insertion loss	dB	1.6 CWDM →OUT	1.6 IN → CWDM	<0.5 CWDM →OUT <0.5 IN → CWDM
Wavelength ripple	dB	<0.5		
Adjacent channel isolation	dB	>15	>30	>25 >25
NON-adjacent channel isolation	dB	>30	>45	
Directivity	dB	>55		
Fiber input and output				
Fibre type		ITU-T-657-A2, G657-B2 And G652-D Compliant. Single mode fibre		
Fibre lenght	mm	1000		
Fibre Jacket	um	900 tight buffer		
Connectors	Type	SC/APC		
Port Identification Color				
COM		Black		Red
1511	nm	Blue		-
1531	nm	Orange		-
1550	nm	-		Yellow
1551	nm	Green		-
1571	nm	Brown		-
2nd window 1310	nm	White		Black

Home Fibre

OPT-RX receivers

Installation using a standard LNB and dish AGC on transmitters enables the use of several different diameter dishes. Cascadable solution similar to MSW distribution
Up to 21dB optical distribution loss
Quick and easy to install
Complete terrestrial bandwidth



OPT-RX DT



OPT-RX 4 MINI



OPT-RX TV

Item		OPT-RX DT	OPT-RX 4 MINI	OPT-RX TV
Code		270693	270666	270696
Optical input	No.		1 SC/APC	
RF Outputs	No.	4 TERR+SAT	4 SAT (VL, HL, VH, HH) + TV	1TERR
Optical input				
Optical connector		SC/APC		
Wavelength	nm		1310	-
Optical return loss	dB		>45	50
Max optical input power	dB		-8	-
RF Outputs				
Bandwidth	MHz		88-862/950-2150	87-862
Connectors	Type		F Female	
Return loss	dB		10	
Output level @ 21dB optical attenuation	dBμV	77 (TV) - 80 (SAT) overall power	82 (TV) - 88 (SAT) overall power	80
Output control		DiSEqC	-	-
Main features				
Mains	Vac/Hz		184-264/50-60	
Power supply	V		14/18 all outputs	
Current consumption	mA	330@18V, 380@14V	180@18V, 230@14V	330@18V, 380@14V
Power consumption	W		7	2.5
Operating temperature	°C		-5 to +50	
LEDs			Green led power supply	
Standard conformity			CEI EN 50083-2 EN60065	

Fibre optic

Home Fibre

V0V series splitters

Small 3mm connector
Cap cover to protect the ferule of the fibres
Small splitters and taps
Tree and star distribution
Quick and easy to install
Wide bandwidth 1260nm – 1590nm



V0V 4

Item		V0V 2	V0V 4
Code		287210	287211
Ways		1X2	1X4
Insertion loss	dB	<3,9	<7,8
Outputs	No.	2	4
Wavelength	nm	1260 - 1650	1260 - 1650
Optical return loss	dB	>50	>50
Max power input	mW	500	500

Home Fibre

V0T series taps

Small 3mm connector
Cap cover to protect the ferule of the fibres
Small splitters and taps
Tree and star distribution
Quick and easy to install
Wide bandwidth 1260nm – 1590nm



V0T 1/2



V0T 7/3

Item		V0T 7/3	V0T 8/3	V0T 9/1
Code		287212	287213	287214
Ways			1	
Trunk line loss	dB	<2,1	<1,5	<0,8
Tap loss	dB	<6,4	<8,5	<12,7
Outputs	No.		1	
Wavelength	nm		1260 - 1650	
Optical return loss	dB	>50	>50	>55
Max power input	mW	500	500	500

Item		V0T 1/2	V0T 2/3	V0T 3/4
Code		287215	287216	287217
Ways			4	
Trunk line loss	dB	<2,5	<3,1	<3,8
Tap loss	dB	<15	<13,7	<11,4
Outputs	No.		4	
Wavelength	nm		1260 - 1650	
Optical return loss	dB	>55	>55	>55
Max power input	mW	500	500	500

Home Fibre accessories

Accessories



Item	code	Description	Pcs
PR003	287219	Single mode pre-terminated fibre cables 3 mt, optical return loss >55	1
PR005	287220	Single mode pre-terminated fibre cables 5 mt, optical return loss >55	1
PR010	287221	Single mode pre-terminated fibre cables 10 mt, optical return loss >55	1
PR025	287222	Single mode pre-terminated fibre cables 25 mt, optical return loss >55	1
PR035	287327	Single mode pre-terminated fibre cables 35 mt, optical return loss >55	1
PR050	287328	Single mode pre-terminated fibre cables 50 mt, optical return loss >55	1
PR075	287329	Single mode pre-terminated fibre cables 75 mt, optical return loss >55	1
PR100	287223	Single mode pre-terminated fibre cables 100 mt, optical return loss >55	1
MIN/MIN	287225	Adaptor Mini-Mini	10
OPTATT3DB	287239	Optic attenuator 3dB	1
OPTATT7DB	287238	Optic attenuator 7dB	1
OPTATT4DB	287237	Optic attenuator 14dB	1
PR ADAPT	287226	Adaptor SC/APC - Mini	1
SUPP V0V/V0T	287240	V0V/ V0T Wall Mount	10
PULL CONN	287224	Pull connector	20

Fibre optic

OPT series

OPT-TX54 and OPT-RX54 are respectively a 4 optical transmitter and a 4 optical receiver for TV-SAT signals in the same housing.



Item		OPT-TX51	OPT-RX51
Code		270689	270690
Optical interface			
Wavelength	nm	1510-1530, 1550-1570	1000-1650
Output power	dBm	5 (each wavelength)	-
Input power	dBm	-	5
RF section			
RF bandwidth	MHz	47-852, 950-2150	
Link gain @dB optical attenuation	dB	3	9
Max. input level @-35dBc	dBμV	117	-
Max. output level @-35dBc	dBμV	-	115
Power supply	Vac, Hz	220-240, 50-60	14/18V
LNB remote supply	mA	300	-
Current consumption	mA	-	240
Power consumption	W	5	4

Fibre optic

K series

KTX optical transmitter converts an RF TV-SAT signal into an optical signal. KRX optical receiver converts the optical signal into a TV-SAT signal.

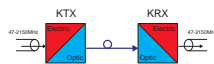

Item		KTX	KRX
Code		270686	270677
Optical interface			
Wavelength	nm	1310±20	1100±1600
Output power	dBm	6	-
Input power	dBm	-	-10 to +6
RF section			
RF bandwidth	MHz	47-2150	
Return loss	dB	>12	>12
Gain	dB	+20	+25
Max. input level	dBμV	89 (88-860MHz) * 79 (950-2150MHz)	-
Max. output level	dBμV	94 (88-860MHz)** 84 (950-2150MHz)	14/18V
Power consumption	mA	80	150
Power supply	V	12	12

Item		KTX-RC	KRX-RC
Code		270671	270672
Optical interface			
Wavelength	nm	1310±20	1100±1600
Output power	dBm	6	-
Input power	dBm	-	-10 to +6
RF section			
RF bandwidth	MHz	47-2150	
Return loss	dB	>12	>12
Gain	dB	+20	+25
Max. input level	dBμV	89 (88-860MHz) * 79 (950-2150MHz)	-
Max. output level	dBμV	94 (88-860MHz)** 84 (950-2150MHz)	14/18V
Power consumption	mA	80	150
Power supply	V	12	12

Fibre optic

Fibre optic solutions

K series

They can be installed anywhere in the distribution network without using a power supply.



Item		KSP1_2	KSP1_4
Code		270679	270680
Optical interface			
Wavelength	nm	1310, 1550	1310, 1550
Output	No.	2	4
Insertion loss	dB	3.2	6.4
Return loss	dB		>45
Isolation	dB		>45
Connectors	Type		SC/ACP

Fibre optic solutions

Headline series

They can be installed anywhere in the distribution network without using a power supply.



Item		SIG7600-HTX	SIG7622	SIG7624
Code		270678	270687	270688
Optical interface				
Wavelength	nm		1310, 1550	1310, 1550
Output	No.		2	4
Insertion loss	dB		3.2	6.4
Return loss	dB		>45	>45
Isolation	dB		>45	>45
Connectors	Type		SC/ACP	SC/ACP

Fibre optic solutions

Accessories

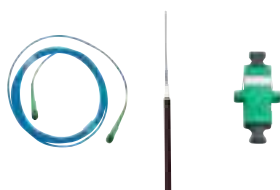

Item	code	Description	Pcs
OPC 4 ARM	287344		1m
4SC/APC CONN	287345		1
OPC 8 ARM	287346		1m
8SC/APC CONN	287347		1
BR2-AA	289360	Singlemode patch cables / 2m with connectors. SC/APC-SC/APC	1
BR4-AA	289362	Singlemode patch cables / 4m with connectors. SC/APC-SC/APC	1
BFO-SC-APC	289349	Adaptor for single mode angled connectors. For mounting in patch panel.	10

Multiswitches

Compact multiswitches

SW145..DT series	106
SWP9..TS series	108
SWP17..TS series	109
SW115..DC series	110
SW19..DC series	110

Cascadable multiswitches

SW144 series	111
SW150XSA series	112
SW185..PLUS series	114
SW189..PLUS series	115
SW19..TS series	116
SW113..TS series	117
SW117..TS series	118

Cascadable SCR multiswitches

SCR414SKY	120
SCR8514	120
SCR543IT	120
SCR583IT	120
SCR583UK	120
SCD2-4216	122

Headend Amplifiers

123

Line Amplifiers

124

Power supplies

126

Accessories

128

Multiswitches

Compact multiswitches



SWI4508DT



4AL827
Power supply
12V 1.4A
Included

SWI45..DT series

5 input compact adjustable multiswitches

- Fully manageable parameters for all the muxes and individual programs (LCN, SID, PDSD, NIT, ...).
- TV and SAT separate gain adjustment
- Return path included
- Satellite Bandwidth up to 2300MHz
- High SAT output level to run long cable drop
- Stand alone included power supply with RCA DC Plug
- Output level LED (red LED On when SAT input signal is low)
- Standard colour coding for easy installation
- Compact size thanks to the matrix system with both sided connectors

Designed to fulfil every installation requirement in small and medium sized distribution systems



- Monitoring LED for the input SAT signal power. (foto LED)
- TV (+3dB) and SAT (+3dB) gain to guarantee the same level as the input to the output.
- External Power Supply (1600mA @12V) with RCAconnector to optimize the installation space and reduce the maintenance time.

Item		SWI4508DT	SWI4512DT	SWI4516DT	SWI4524DT	SWI4532DT
Code		271148	271149	271150	271151	271152
Inputs	No.			4 SAT, 1 TV		
Outputs	No.	8	12	16	24	32
SAT	Bandwidth	MHz		950-2400		
	Gain	dB		3		
	Gain adjustment	dB		12		
	Max. output level (-35dBc 2 ton.)	dB μ V		102		
TV	Bandwidth	MHz		85-862		
	Gain	3	3	-2	-2	-2
	Gain adjustment	dB		12		
	Max. output level (-35dBc 2 ton.)	dB μ V		97		
Return path	Bandwidth	MHz		5-65		
	Gain	-8	-8	-13	-13	-13
Isolation SAT-SAT	dB			> 25		
Power consumption	mA			400		
LNB power supply	mA			600		
TV power supply	mA			170		
Dimensions (l x h x w)	mm	145x120x25	200x120x25	260x120x25	340x120x25	420x120x25
Operating temperature	°C			-10 to +55		

Installation Example

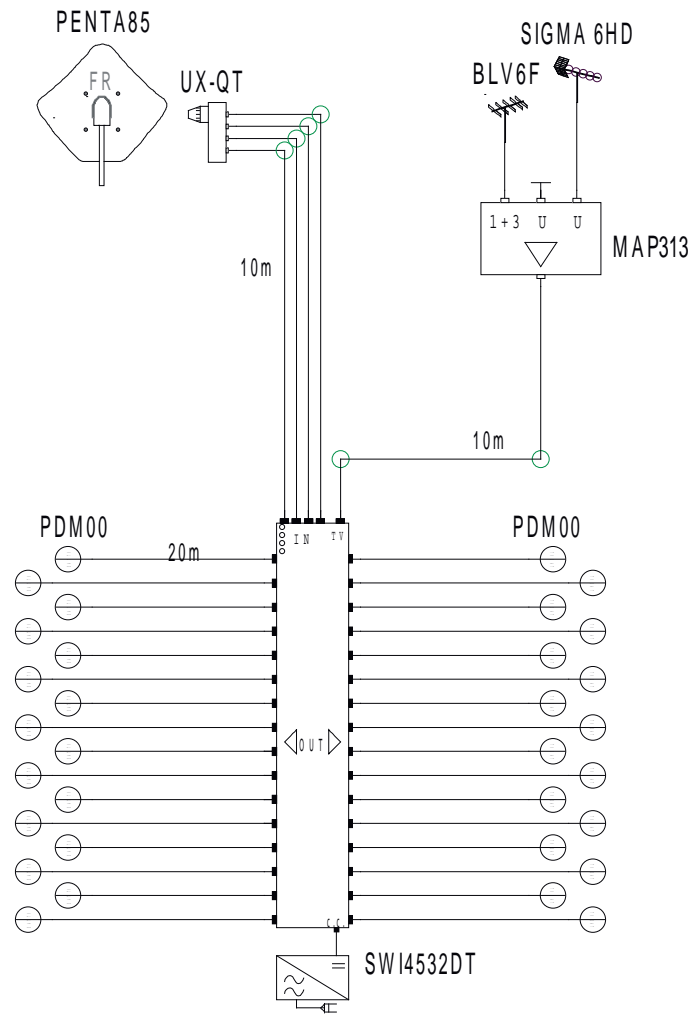

PSU technical specifications

Item	4AL827	
Code	4AL827	
Output voltage	V	12
Maximum output current	mA	1400
Supply voltage	V, Hz	186-264, 50-60
Power consumption	W	24
Isolation	Class	II
Connector	Type	RCA
Dimensions	mm	145x120x70
Operating temperature	°C	-10 ÷ +55

Multiswitches

Compact multiswitches

SWP9..TS series

9 input compact multiswitches



SWI916TS



PSU1315TS
Power supply
13V 1,5A
Included

- Dip Switch to select Active or Passive TV gain
- Return path included when TV gain is passive
- Satellite bandwidth up to 2300MHz
- PSU1315TS: stand alone included power supply with M-Type Jack Plug (2.1x5.5x12; internal positive, external negative)
- Standard colour coding for easy installation
- Compact size thanks to the matrix system with both sided connectors
- Cost effective

It was designed to fulfil every installation requirement in small and medium size distribution systems.



- The product is entirely fed by tap ports, only when TV active is enable, it has to be fed by DC-PLUG. The Power Supply Unit is included (see page XX)
- Each port has a LED which shows the correct reception of the STB DiSEqC command.
- The product can be used with SWA930TS amplifier, which allows to adjust appropriately the satellite and TV gains.

Item			SWP908TS	SWP912TS	SWP916TS	SWP924TS	SWP932TS
Code			287350	287351	287352	287353	287354
Inputs		No.	8 SAT, 1 TV				
Outputs		No.	8	12	16	24	32
SAT	Bandwidth	MHz	950 - 2300				
	Gain (uptilt 4dB)	dB	2	1	1	-1	-2
	Max. output level (-35dBc 2 ton.)	dBμV	100				
TV	Bandwidth	MHz	Passive TV gain: 5-862 Active TV gain: 47-862				
	Gain (active/passive)	dB	1/-19	0/-20	-1/-21	-2/-22	-4/-24
	Max. output level (-35dBc 2 ton.)	dBμV	95				
Return path	Bandwidth	MHz	Passive TV gain: 5-65				
Isolation SAT-SAT		dB	> 30				
Power consumption		mA	Active TV gain: 160 Passive TV gain: entirely fed by the receivers				
Tap consumption		mA	50				
LNB power supply		mA	Passive TV gain: 1500 Active TV gain: 1340				
Dimensions (l x h x w)		mm	110x190x40	170x190x40	170x190x40	230x190x40	300x190x40
Operating temperature		°C	-10 to +55				

Compact multiswitches

SWP17..TS series

17 input compact multiswitches

- Dip Switch to select Active or Passive TV gain
- Return path included when TV gain is passive
- Satellite bandwidth up to 2300MHz
- PSU1340TS: stand alone included power supply with M-Type Jack Plug (2.1x5.5x12; internal positive, external negative)
- Standard colour coding for easy installation
- Compact size thanks to the matrix system with both sided connectors
- Cost effective

It was designed to fulfil every installation requirement in small and medium size distribution systems.

- The product is entirely fed by tap ports, only when TV active is enable, it has to be fed by DC-PLUG. The Power Supply Unit is included. (see page XX)
- Each port has a LED which shows the correct reception of the STB DiSEqC command.
- The product can be used with SWA1730TS amplifier, which allows to adjust appropriately the satellite and TV gains.



SWP1712TS



PSU1340TS
Power supply
13V 4A
Included

Item		SWP1708TS	SWP1712TS	SWP1716TS	SWP1724TS	SWP1732TS
Code		287355	287356	287357	287358	287359
Inputs	No.	16 SAT, 1 TV				
Outputs	No.	8	12	16	24	32
SAT	Bandwidth	MHz 950-2300				
	Gain (uptilt 4dB)	dB 0	-1	-1	-3	-4
	Max. output level [-35dBc 2 ton.]	dBμV 100				
TV	Bandwidth	MHz Passive TV gain: 5-862 Active TV gain: 47-862				
	Gain (active/passive)	dB 0/-20	-1/-21	-2/-22	-3/-23	-5/-25
	Max. output level [-35dBc 2 ton.]	dBμV 95				
Return path	Bandwidth	MHz Passive TV gain: 5-65				
Isolation SAT-SAT	dB	> 30				
Power consumption	mA	Active TV gain: 160 Passive TV gain: entirely fed by the receivers				
Tap consumption	mA	50				
LNB power supply	mA	Passive TV gain: 4000 Active TV gain: 3840				
Dimensions (l x h x w)	mm	120x310x40	190x310x40	190x310x40	260x310x40	310x310x40
Operating temperature	°C	-10 to +55				

Multiswitches

Compact multiswitches

SWI5..DC series

5 input compact multiswitches

- High SAT output level to run long cable drop
- The LNB and the multiswitch can be entirely fed by the receivers
- Circuit for automatic detection and 12V supply current for terrestrial masthead amplifier. Fracarro patented
- Additional F connector to supply on terrestrial input when necessary
With the Mini DiSEqC and Tool Kit it is possible to distribute up to 4 satellites (16 polarities) + TV
- Standard colour coding for easy installation



SWI508DC



Item		SWI508DC	SWI516DC
Code		271115	271117
Inputs	No.	4 SAT, 1 TV	
Outputs	No.	8	16
SAT	Bandwidth	MHz	950-2150
	Gain (tilt)	dB	-2 to 2
	Max out. level (-35dBc 2 ton.)	dB μ V	110
TV	Bandwidth	MHz	5-862
	Gain	dB	-16
Return path	Bandwidth	MHz	5-65
	Gain	dB	-16
Isolation SAT-SAT	dB	> 30	
Power consumption	mA	35	35
Dimensions (l x h x w)	mm	200x120x30	360x120x30
Operating temperature	°C	-10 to +55	

Compact multiswitches

SWI9..DC series

9 input compact multiswitches

- Dip Switch to select Active or Passive TV gain
- High SAT output level to run long cable drop
- The LNB and the multiswitch can be entirely fed by the receivers
Circuit for automatic detection and 12V supply current for terrestrial masthead amplifier. Fracarro patented
- Additional F connector to supply on terrestrial input when necessary
- Standard colour coding for easy installation



SWI908DC



Item		SWI908DC	SWI916DC	
Code		271118	271119	
Inputs	No.	8 SAT + 1 TV		
Outputs	No.	8	16	
SAT	Bandwidth	MHz	950-2150	
	Gain	dB	-2 to 2	
	Max. output level (-35dBc 2 ton.)	dB μ V	105	
TV	Bandwidth	MHz	88-862	
	Gain (active/passive)	dB	0/-16	-3/-20
	Max. output level (-35dBc 2 ton.)	dB μ V	Active TV gain: 97	
Return path	Bandwidth	MHz	5-65	
	Gain	dB	-16	-20
Isolation SAT-SAT	dB	> 30		
Power consumption	mA	Passive TV gain: 60 (per output) Active TV gain: 60 (per output) + 70 (TV amplifier)		
Dimensions (l x h x w)	mm	230x180x30	390x180x30	
Operating temperature	°C	-10 to +55		

Cascadable multiswitches

SWI44 series

4 input cascadable multiswitches

- 3 different levels of attenuation -17dB, -8dB and 0dB for signal balancing
- High SAT output level to run long cable drop
- The multiswitch is entirely fed by receivers, the LNB can be fed by receivers or through trunk lines
- Plastic bracket and Standard colour coding for quick and easy installation
- Cost effective

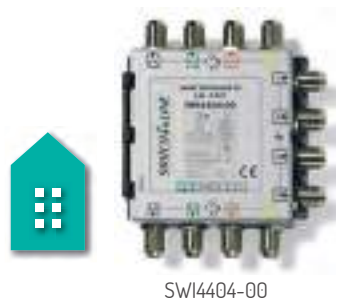

Item		SWI4404-00	SWI4404-08	SWI4404-17	
Code		271081	271082	271083	
Inputs	No.		4 SAT		
Outputs	No.		4 SAT		
SAT	Bandwidth	MHz	950-2150		
	Gain	dB	0	-8	-17
	Max. output level (-35dBc 2 ton.)	dBµV	105	105	-
	Insertion loss	dB		-2	
Isolation SAT-SAT	dB		> 28		
Power consumption	mA	35	35	15	
Dimensions (l x h x w)	mm		90x70x20		
Operating temperature	°C		-10 to 55		

Item		SWI4406-00	SWI4406-08	SWI4406-17	
Code		271084	271085	271086	
Inputs	No.		4 SAT		
Outputs	No.		6 SAT		
SAT	Bandwidth	MHz	950-2150		
	Gain	dB	0	-8	-17
	Max. output level (-35dBc 2 ton.)	dBµV	105	105	-
	Insertion loss	dB		-2	
Isolation SAT-SAT	dB		> 28		
Power consumption	mA	35	35	15	
Dimensions (l x h x w)	mm		119x70x20		
Operating temperature	°C		-10 to 55		

Item		SWI4408-00	SWI4408-08	SWI4408-17	
Code		271087	271088	271089	
Inputs	No.		4 SAT		
Outputs	No.		8 SAT		
SAT	Bandwidth	MHz	950-2150		
	Gain	dB	0	-8	-17
	Max. output level (-35dBc 2 ton.)	dBµV	105	105	-
	Insertion loss	dB		-2	
Isolation SAT-SAT	dB		> 28		
Power consumption	mA	35	35	15	
Dimensions (l x h x w)	mm		150x70x20		
Operating temperature	°C		-10 to 55		

Multiswitches

Cascadable multiswitches



SWI504SA

SWI50XSA series

5 input cascadable adjustable multiswitches

- SAT gain adjustment
- Return path included
- Satellite bandwidth up to 2300MHz
- High SAT output level to run long cable drop
- The multiswitch is entirely fed by the receiver
- Standard colour coding for easy installation
- Compact size thanks to the matrix system with both sided connectors
- Cost effective



It was designed to fulfil every installation requirement in small and medium size distribution systems

- Power LED and TV LED. There is a Power SAT LED which shows the correct feed of the product and there is a Power TV LED which shows the presence of DC on TV trunk line.
- The product can be used with SWA5424, SWA5414 and SWA5122 amplifiers, which allows to adjust appropriately satellite and TV gains.
- Active Satellite gain to maintain the same level from the input to the output, passive TV to work with every input level
- DC pass on all satellite and TV lines

Item		SWI504SA	SWI506SA	SWI508SA
Code		271161	271162	271163
Inputs	No.		4 SAT, 1 TV	
Outputs	No.	4	6	8
SAT	Bandwidth	MHz	950-2300	
	Gain (uptilt 5dB)	dB	1	
	Gain adjustment	dB	20	
	Max. output level (-35dBc 2 ton.)	dB μ V	102	
	Insertion loss	dB	-1	
TV	Bandwidth	MHz	88-790	
	Gain	dB	-25	-28
	Insertion loss	dB		-1,5
Isolation SAT-SAT	dB		> 30	
Tap consumption	mA	160	170	180
Max. SAT trunk current	mA		2000	
Max. TV trunk current	mA		1000	
Dimensions (l x h x w)	mm	120x120x30	140x120x30	160x120x30
Operating temperature	°C		-10 to 55	

Installation Example

Very low insertion loss, it allows to distribute the signal up to 6 floors without launch amplifier

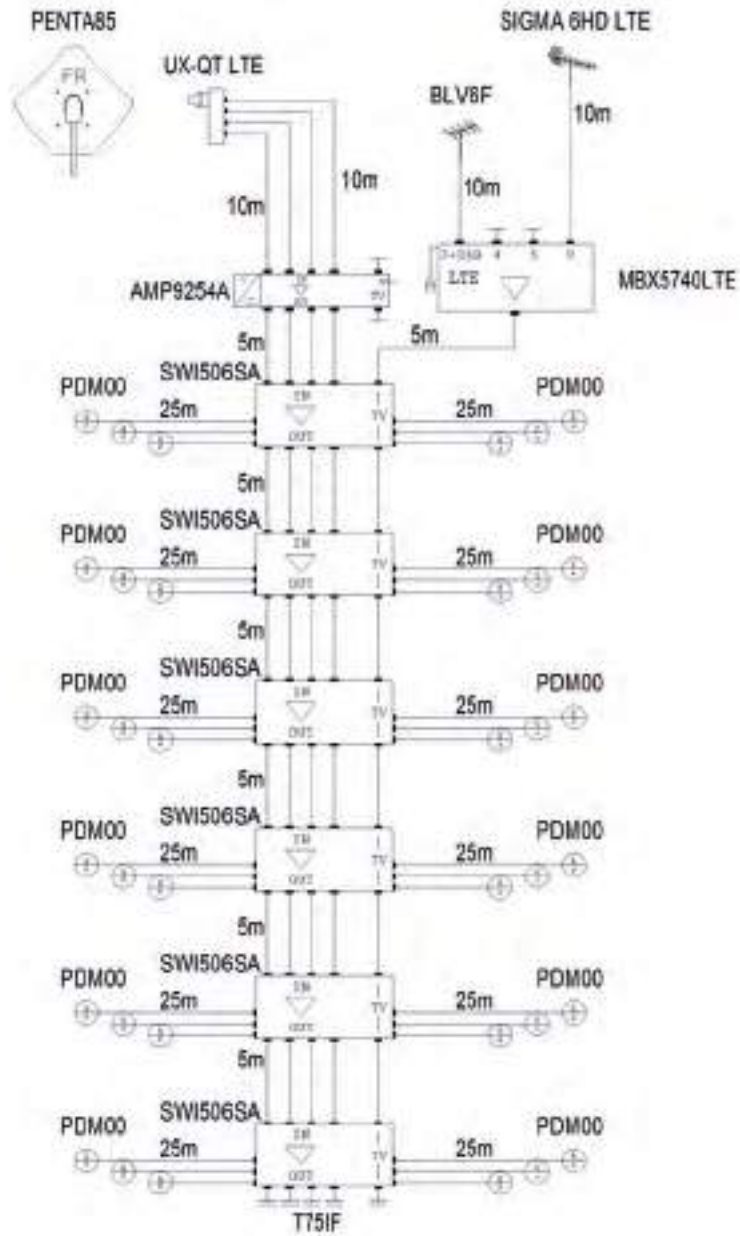

Multiswitches

Cascadable multiswitches



SWI8516PLUS



SWI8532STPLUS

SWI85..PLUS series

5 input cascadable adjustable multiswitches

SWI89..PLUS series

9 input cascadable adjustable multiswitches

Main Characteristics

- 2xSAT separate gain adjustment (high and low band)
 - TV gain adjustment
 - Return path included
 - Very High SAT output level to run very long cable drop
 - Very High isolation
 - Optimized energy consumption
 - Standard colour coding for easy installation
- With SWI8508PLUS, SWI8512PLUS and SWI8516PLUS, the Mini DiSeqC and Tool Kit it is possible to distribute up to 4 satellites (16 polarities) + TV



SWI8916PLUS



Item		SWI8508PLUS	SWI8512PLUS	SWI8516PLUS	SWI8524STPLUS	SWI8532STPLUS	
Code		271055	271056	271063	271057	271058	
Inputs	No.			4 SAT, 1 TV			
Outputs	No.	8	12	16	24	32	
SAT	Bandwidth			950-2150			
	Gain (uptilt)	dB	-5 to -1	-4 to 0	-3 to 1	-6 to 0	-5 to +1
	Gain adjustment	dB	15				
	Max. output level (-35dBc 2 ton.)	dBμV	110	110	108	110	108
	Insertion loss	dB	-1,5	-2	-2,5	-4	-5
TV	Bandwidth			85-862			
	Gain	dB	-5 to -1	-7 to -3	-9 to -5	-9 to -3	-11 to -5
	Gain adjustment	dB	20				
	Max. output level (-35dBc 2 ton.)	dBμV	107	105	102	105	102
	Insertion loss	dB	-1	-1,5	-2	-3	-4
Return path	Bandwidth			5-65			
	Gain	dB	-4	-5	-6	-5	-6
	Max. output level (-35dBc 2 ton.)	dBμV	100				
	Insertion loss	dB	-1	-1	-1	-2	-2
Isolation SAT-SAT	dB	> 45					
Power consumption	mA, V	280, 14 220, 18		560, 14 440, 18			
Dimensions (l x h x w)	mm	260X120X30	340x120x30	425x120x30	355x120x60	440x120x60	
Operating temperature	°C	-10 to 55					

Installation Example

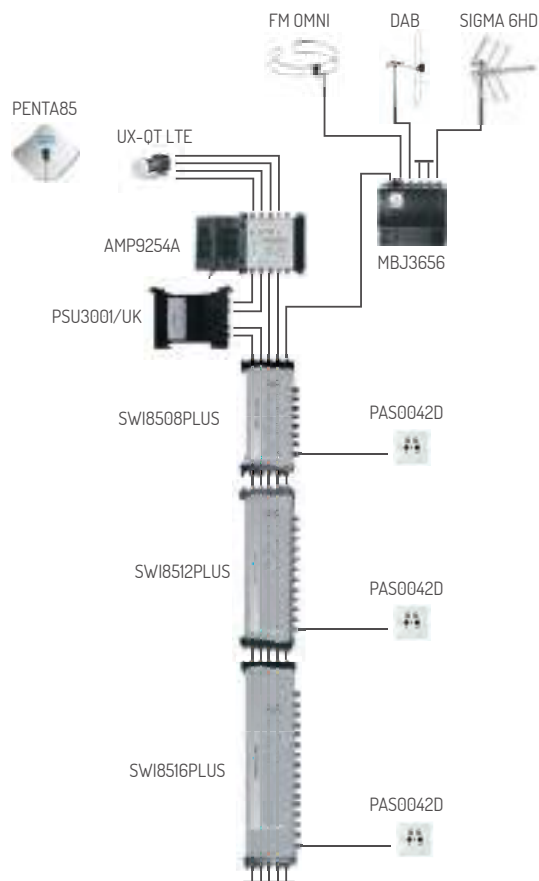

The system can be powered from the headend via the PSU3001/UK, which has built-in twin power inserters. Attenuation control to adjust output levels.

Item		SWI8908PLUS	SWI8912PLUS	SWI8916PLUS	
Code		271067	271068	271069	
Inputs	No.		8 SAT, 1 TV		
Outputs	No.	8	12	16	
SAT	Bandwidth	MHz	950-2150		
	Gain (uptilt)	dB	-2 to 3	-3 to 2	
	Gain adjustment	dB		15	
	Max. output level [-35dBc 2 ton.]	dBμV	110	110	108
	Insertion loss	dB	-2	-2.5	-3
TV	Bandwidth	MHz	85-862		
	Gain	dB	-7 to -3	-9 to -4	-11 to -5
	Gain adjustment	dB		20	
	Max. output level [-35dBc 2 ton.]	dBμV	107	105	102
	Insertion loss	dB	-1,5	-2	-2,5
Return path	Bandwidth	MHz	5-65		
	Gain	dB	-3	-5	-7
	Max. output level [-35dBc 2 ton.]	dBμV		100	
	Insertion loss	dB		-1,5	
Isolation SAT-SAT	dB		> 45		
Power consumption	mA, V		350, 14 280, 18		
Dimensions (l x h x w)	mm	260x180x30	340x180x30	425x180x30	
Operating temperature	°C		-10 to 55		

Multiswitches

Cascadable multiswitches



SWI916TS



PSU1315TS
Power supply
13V 1,5A
Not Included

SWI9..TS series

9 input cascadable multiswitches

- Dip Switch to select Active or Passive TV gain
- Return path included when TV gain is passive
- Satellite bandwidth up to 2300MHz
- PSU1315TS: stand alone power supply with M-Type Jack Plug (2.1x5.5x12; internal positive, external negative). Not included
- Standard colour coding for easy installation
- Compact size thanks to the matrix system with both sided connectors
- Cost effective



It was designed to fulfil every installation requirement in small and medium size distribution systems

- The product is entirely fed by tap ports, only when TV active is enable, it has to be fed by trunk line or DC-PLUG (see page XX).
- Each port has a LED which shows the correct reception of the STB DiSEqC command.
- The product can be used with SWA930TS amplifier, which allows to adjust appropriately the satellite and TV gains.

Item			SWI908TS	SWI912TS	SWI916TS	SWI924TS	SWI932TS
Code			287360	287361	287362	287363	287364
Inputs		No.	8 SAT, 1 TV				
Outputs		No.	8	12	16	24	32
SAT	Bandwidth	MHz	950 - 2300				
	Gain (uptilt 4dB)	dB	2	1	1	-1	-2
	Max. output level (-35dBc 2 ton.)	dBμV	100				
	Insertion Loss (down tilt)	dB	-1 to -3	-1 to -4	-1 to -5	-1,5 to -6	-1,5 to -7,5
TV	Bandwidth	MHz	Passive TV gain: 5-862 Active TV gain: 47-862				
	Gain (active/passive)	dB	-2/-22	-3/-23	-4/-24	-5/-25	-6/-26
	Max. output level (-35dBc 2 ton.)	dBμV	95				
	Insertion Loss (down tilt)	dB	-3 to -4	-3 to -4,5	-3 to -4,5	-3 to -4,5	-3 to -5
Return path	Bandwidth	MHz	Passive TV gain: 5-65				
Isolation SAT-SAT		dB	> 30				
Power consumption		mA	Active TV gain: 160 Passive TV gain: entirely fed by the receivers				
Tap consumption		mA	50				
LNB power supply		mA	Passive TV gain: 1500 Active TV gain: 1340				
Dimensions (lxbxw)		mm	110x190x40	170x190x40	170x190x40	230x190x40	300x190x40
Operating temperature		°C	-10 to +55				

Cascadable multiswitches

SWI13..TS series

13 input cascadable multiswitches



SWI1316TS



PSU1340TS
Power supply
13V 4A
Not Included

- Dip Switch to select Active or Passive TV gain
- Return path included when TV gain is passive
- Satellite bandwidth up to 2300MHz
- PSU1340TS: stand alone power supply with M-Type Jack Plug (2.1x5.5x12; internal positive, external negative). Not included
- Standard colour coding for easy installation
- Compact size thanks to the matrix system with both sided connectors
- Cost effective



It was designed to fulfil every installation requirement in small and medium size distribution systems

- The product is entirely fed by tap ports, only when TV active is enable, it has to be fed by trunk line or DC-PLUG (see page XX).
- Each port has a LED which shows the correct reception of the STB DiSEqC command.
- The product can be used with SWA1730TS amplifier, which allows to adjust appropriately the satellite and TV gains.

Item		SWI1308TS	SWI1312TS	SWI1316TS
Code		287365	287366	287367
Inputs	No.		12 SAT, 1 TV	
Outputs	No.	8	12	16
SAT	Bandwidth	MHz	950 - 2300	
	Gain (uptilt 4dB)	dB	0	-1
	Max. output level [-35dBc 2 ton.]	dBµV		100
	Insertion Loss (down tilt)	dB	-1 to -3	-1 to -5
TV	Bandwidth	MHz	Passive TV gain: 5-862 Active TV gain: 47-862	
	Gain (active/passive)	dB	-2/-22	-3/-23
	Max. output level [-35dBc 2 ton.]	dBµV		95
	Insertion Loss (down tilt)	dB	-4 to -5	-4 to -5
Return path	Bandwidth	MHz	Passive TV gain: 5-65	
Isolation SAT-SAT	dB		> 30	
Power consumption	mA		Active TV gain: 160 Passive TV gain: entirely fed by the receivers	
Tap consumption	mA		50	
LNB power supply	mA		Passive TV gain: 4000 Active TV gain: 3840	
Dimensions (l x h x w)	mm	120x310x40	190x310x40	190x310x40
Operating temperature	°C		-10 to +55	

Multiswitches

Cascadable multiswitches



SWI1716TS



PSUI340TS
Power supply
13V 1.5A
Not Included

SWI17..TS series

17 input cascadable multiswitches

- Dip Switch to select Active or Passive TV gain
- Return path included when TV gain is passive
- Satellite bandwidth up to 2300MHz
- PSUI340TS: stand alone power supply with M-Type Jack Plug (2.1x5.5x12; internal positive, external negative). Not included
- Standard colour coding for easy installation
- Compact size thanks to the matrix system with both sided connectors
- Cost effective



It was designed to fulfil every installation requirement in small and medium size distribution systems

- The product is entirely fed by tap ports, only when TV active is enable, it has to be fed by trunk line or DC-PLUG (see page XX).
- Each port has a LED which shows the correct reception of the STB DiSEqC command.
- The product can be used with SWA1730TS amplifier, which allows to adjust appropriately the satellite and TV gains.

Item			SWI1708TS	SWI1712TS	SWI1716TS	SWI1724TS	SWI1732TS		
Code			287368	287369	287370	287371	287372		
Inputs			No.		16 SAT, 1 TV				
Outputs			No.		8	12	16	24	32
SAT	Bandwidth	MHz	950 - 2300						
	Gain (uptilt 4dB)	dB	0	-1	-1	-3	-4		
	Max. output level (-35dBc 2 ton.)	dBμV	100						
	Insertion Loss (down tilt)	dB	-1 to -3	-1 to -4	-1 to -5	-2 to -6,5	-2 to -8		
TV	Bandwidth	MHz	Passive TV gain: 5-862 Active TV gain: 47-862						
	Gain (active/passive)	dB	-2/-22	-3/-23	-4/-24	-5/-25	-7/-27		
	Max. output level (-35dBc 2 ton.)	dBμV	95						
	Insertion Loss (down tilt)	dB	-4 to -5	-4 to -5	-4 to -5	-4 to -5,5	-4 to -6		
Return path	Bandwidth	MHz	Passive TV gain: 5-65						
Isolation SAT-SAT			dB					> 30	
Power consumption			mA					Active TV gain: 160 Passive TV gain: entirely fed by the receivers	
Tap consumption			mA					50	
LNB power supply			mA					Passive TV gain: 4000 Active TV gain: 3840	
Dimensions (l x h x w)			mm	120x310x40	190x310x40	190x310x40	260x310x40	310x310x40	
Operating temperature			°C					-10 to +55	

Installation Example

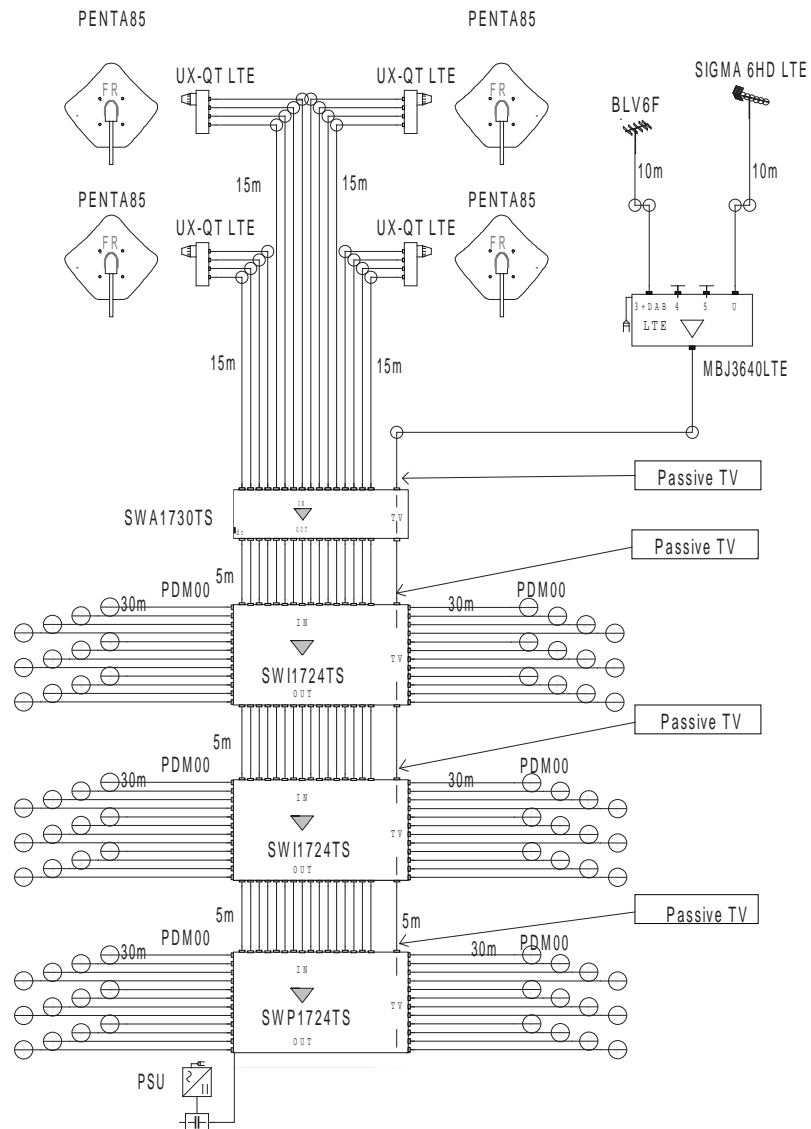
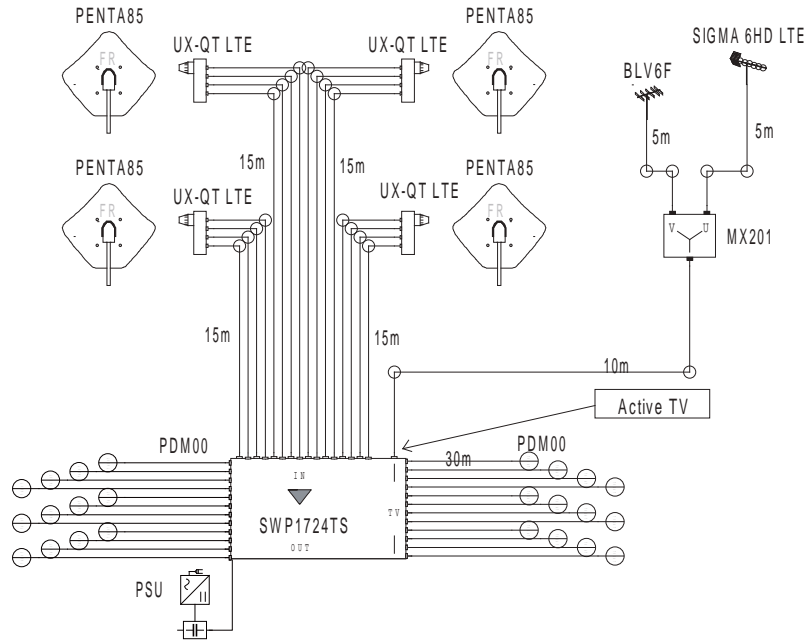

Multiswitches

Cascadable SCR multiswitches

SCR414SKY

4 inputs cascadable SCR multiswitch



- 4 inputs, 4 trunk outputs and 1 tap output to serve up to 4 SCR decoders (4 frequencies) through only one coaxial cable
- Automatic Gain Control maintains an adequate output level even if the input level changes
- Very Low Insertion Loss ideal for cascading several multiswitches or to upgrade existing systems
- The multiswitch is entirely fed by receiver, the LNB can be fed by receiver or through trunk lines
- Standard colour coding for easy installation
- Compact size
- Cost effective
- LED which allows to determine which user bands have been recognized by the multiswitch;
- this LED repeats a 4-blinks sequence, one for each user band
- SKY ITALY APPROVED



SCR8514

5 inputs cascadable adjustable SCR multiswitch



- 5 inputs, 5 trunk outputs and 1 tap output to serve up to 4 SCR decoders (4 frequencies) with mixed TV through only one coaxial cable
- High SAT and TV gain for splitting compensation
- TV and SAT separate gain adjustment
- Very High SAT output level
- Very Low Insertion Loss ideal for cascading several multiswitches or to upgrade existing systems
- Standard colour coding for easy installation



Cascadable SCR multiswitches

SCR543IT

5 inputs cascadable SCR multiswitch



SCR543IT

- 5 inputs, 5 trunk outputs and 4 tap outputs to serve:
- 4 traditional legacy decoders
- 12 SCR decoders (4 ports x 3 freq. SCR through only 4 cables)

SCR583IT SCR583UK

5 inputs cascadable SCR multiswitch



SCR583UK

- 5 inputs, 5 trunk outputs and 8 tap outputs to serve:
- 8 traditional legacy decoders
- 24 SCR decoders (4 ports x 3 freq. SCR through only 4 cables)

Main Characteristics

- Automatic Gain Control maintains an adequate output level even if the input level changes
- 1 passive TV input with LTE filter
- Very Low Insertion Loss ideal for cascading several multiswitches or to upgrade existing systems
- Compact size thanks to the matrix system with both sided connectors
- The multiswitch is entirely fed by the receivers
- Standard colour coding for easy installation

Autodetection of SCR and Legacy mode; this functionality allows to substitute a legacy decoder with an SCR decoder without any intervention on the installation. The multiswitch starts up in legacy mode, and it switches automatically to SCR mode once an SCR command is received on its output; this is indicated by a flashing LED on output port. Stand alone power supply useful for supply all the other parts of satellite installation;



Installation Example

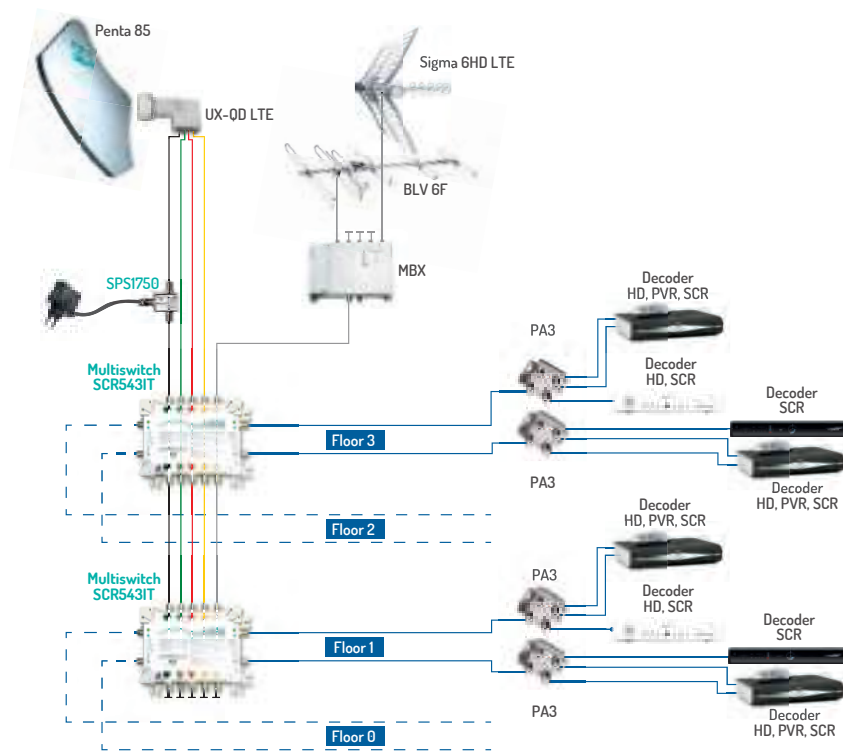

Item		SCR8514	SCR414SKY	SCR543IT	SCR583IT	SCR583UK	
Code		271121	271127	287334	287335	287336	
Inputs	No.	4 SAT, 1 TV	4 SAT	4 SAT, 1 TV	4 SAT, 1 TV	4 SAT, 1 TV	
Outputs	No.	1 4 SCR users	1 4 SCR users	4 4 legacy users or 12 total SCR users	8 8 legacy users 24 total SCR users	8 8 legacy users 24 total SCR users	
SAT	Bandwidth	MHz		950-2150			
	Gain	dB	position 1: 16 position 2: 7	-	-	-	
	CAG	dB	-	55 - 90	60 - 91	60 - 91	
	Max. output level [-35dBc 2 ton.]	dBμV	105	90	SCR: 90 Legacy: 80	SCR: 90 Legacy: 80	SCR: 90 Legacy: 80
	SCR Frequencies	MHz	1210, 1420, 1680, 2040	1210, 1420, 1680, 2040	1210, 1420, 1680	1210, 1420, 1680	1280, 1382, 1484
	Insertion Loss	dB	1	1	1,5	2,5	2,5
TV	Bandwidth	MHz	85-862	-	5 - 1000	5 - 1000	5 - 1000
	Tap Bandwidth	MHz	85-862	-	5 - 790	5 - 790	5 - 790
	Gain	dB	12	-	-24	-24	-24
	Gain adjustment	dB	15				
	Max. output level [-35dBc 2 ton.]	dBμV	107	-	-	-	-
	Insertion Loss	dB	1	-	3	5	5
Isolation SAT-SAT	dB		30	35	35	35	
Power consumption	mA	280	0	0	0	0	
Tap consumption	mA	-	145	85	85	85	
LNB power supply	mA	-	500 (HH)	500	500	500	
Dimensions (l x h x w)	mm	120x120x35	81x76x22	122 x 158 x 50	202 x 158 x 50	202 x 158 x 50	
Operating temperature	°C			-10 to +55			

Multiswitches

Cascadable multiswitches



SCR543IT

SCD2-4216

4 inputs cascadable SCD2 (dCSS) multiswitch

- 4 inputs, 4 trunk outputs and 2 user outputs to serve up to 32 users (16 different frequencies for each output) on only two cables
- Automatic Gain Control (AGC): it maintains an adequate output level even if the input level changes
- Very Low Insertion Loss ideal for cascading several multiswitches or to upgrade existing systems
- The multiswitch is entirely fed by receiver
- DC pass on all satellite ports: maximum compatibility with existing systems
- Standard colour coding for easy installation
- Compact size
- Cost effective



Item		SCD2-4216	
Code		271129	
Inputs	No.	4 SAT	
Outputs	No.	2 (to serve up to 32 SCR dCSS users)	
SAT	Bandwidth	MHz	950 - 2150
	Gain	dB	-
	CAG	dB	60 - 90
	Max. output level (-35dBc 2 ton.)	dB μ V	84
	SCR Frequencies	MHz	1210, 1420, 1680, 2040 (responding to EN50494 commands) 985, 1050, 1115, 1275 1340, 1485, 1550, 1615 1745, 1810, 1875, 1940 (responding to EN50607 commands)
	Insertion Loss	dB	1
TV	Bandwidth	MHz	-
	Tap Bandwidth	MHz	-
	Gain	dB	-
	Gain adjustment	dB	-
	Max. output level (-35dBc 2 ton.)	dB μ V	-
	Insertion Loss	dB	-
Isolation SAT-SAT	dB	30	
Power consumption	mA	0	
Tap consumption	mA	365	
LNB power supply	mA	2000	
Dimensions (l x h x w)	mm	80x105x22	
Operating temperature	°C	-10 to +55	

Headend Amplifiers

AMP9254

Headend amplifier with 5 inputs (4 SAT, 1 TV)



- Gain adjustment for each SAT input
- High SAT output level
- For small and medium systems
- Standard colour coding for easy installation



AMP9254A

Headend amplifier with 5 inputs (4 SAT, 1 TV)



- High SAT amplification
- Tilt and gain adjustment for each SAT input
- Very High SAT output level
- For medium and large systems or where there are long distances between multiswitches
- Additional F DC connector to insert an external power supply on lines 1 and 2
- Standard colour coding for easy installation



AMP9294

Headend amplifier with 9 inputs (8 SAT, 1 TV)



- Gain adjustment for each SAT input
- High SAT output level
- For small and medium systems
- Standard colour coding for easy installation



Item		AMP9254	AMP9254A	AMP9294	
Code		271031	271033	271032	
Inputs	No.	4 SAT, 1 TV	4 SAT, 1 TV	8 SAT, 1 TV	
SAT	Bandwidth	MHz	950-2150		
	Gain	dB	25	32	24
	Slope	dB	6		4
	Gain adjustment	dB		15	
	Slope adjustment	dB	-	12	-
	Max. output level (-35dBc 2 ton.)	dBµV	112	116	112
TV	Bandwidth	MHz	5-862		
	Insertion Loss (down tilt)		-1		
Mains voltage	V, Hz	220-240, 50-60			
LBN power supply	mA, V	400, 14	400, 14	600, 14	
Dimensions (l x h x w)	mm	235x125x65	235x125x65	320x125x65	
Operating temperature	°C	-10 to 55			

Multiswitches

Line Amplifiers



SWA5424

4 SAT inputs adjustable line amplifier

- Tilt and gain adjustment for each SAT input
- Very High SAT output level
- For medium and large systems or where there are long distances between multiswitches
- Remote power supply through VL, HL and VH SAT trunk lines
- DC Pass through HH line
- Standard colour coding for easy installation



SWA5414

4 SAT inputs line amplifier

- Fixed gain
- For small and medium systems (sostituire con logo)
- Can be powered directly through the additional F DC connector or by using an external power supply connected to the VL SAT trunk line
- Compact size
- Cost effective
- Standard colour coding for easy installation



SWA5122

2 inputs (1 SAT and 1 TV) adjustable line amplifier

- High TV amplification
- Tilt and gain adjustment for TV input
- Return path gain adjustment
- Very High TV output level
- For medium and large systems or where there are long distances between multiswitches
- Remote power supply through SAT trunk lines
- Standard colour coding for easy installation



SWA930TS

9 inputs adjustable line amplifier

SWA1730TS

17 inputs adjustable line amplifier

Main Characteristics

- High SAT amplification
- Gain adjustment for each SAT input
- Dip switch and Gain adjustment for TV input
- Satellite bandwidth up to 2300MHz
- High SAT output level
- DC Pass on each SAT port
- Standard colour coding for easy installation
- Compact size
- Cost effective



it was designed to fulfil every installation requirement in small and medium distribution systems.

Each port has to be fed, there is a LED which shows that it is correctly fed

The SWA930TS can be used with SWI9xxTS and SWP9xxTS multiswitches.

The SWA1730TS can be used with SWI13xxTS, SWI17xxTS, SWP13xxTS and SWP17xxTS multiswitches.

Item		SWA5424	SWA5414	SWA5122	SWA930TS	SWA1730TS	
Code		271034	271036	271035	287373	287374	
Inputs	No.	4 SAT	4 SAT	1 SAT, 1 TV	8 SAT, 1 TV	16 SAT, 1 TV	
SAT	Bandwidth	MHz	950-2150	950-2150	950-2150	950 - 2300	
	Gain	dB	25	16	-1	30	
	Slope	dB	-	4	-	10	
	Gain adjustment	dB	15	-	-	20	
	Slope adjustment	dB	15	-	-	-	
	Max. output level [-35dBc 2 ton.]	dB μ V	116	108	-	112	112
TV	Bandwidth	MHz	-	-	85-862	Passive TV gain: 5-862 Active TV gain: 47-862	
	Gain	dB	-	-	30	Passive TV gain: -2 Active TV gain: 18	
	Gain adjustment	dB	-	-	15	20	20
	Slope adjustment	dB	-	-	15	-	-
	Max. output level [-35dBc 2 ton.]	dB μ V	-	-	116	110	110
Return path	Bandwidth	MHz	-	-	5-65		
	Gain	dB	-	-	15		
	Gain adjustment	dB	-	-	10		
	Max. output level [-35dBc 2 ton.]	dB μ V	-	-	106		
Power supply	V	14-30	5-18	14-30 on SAT lines	13-14	13-14	
Power consumption	mA, V	300, 14	120, 14	400, 14	Passive TV gain: 1000 Active TV gain: 1150	Passive TV gain: 2000 Active TV gain: 2150	
Dimensions (l x h x w)	mm	198x108x30	90x90x20	198x108x30	170x120x40	290x120x40	
Operating temperature	°C			-10 to 55			

Installation Example

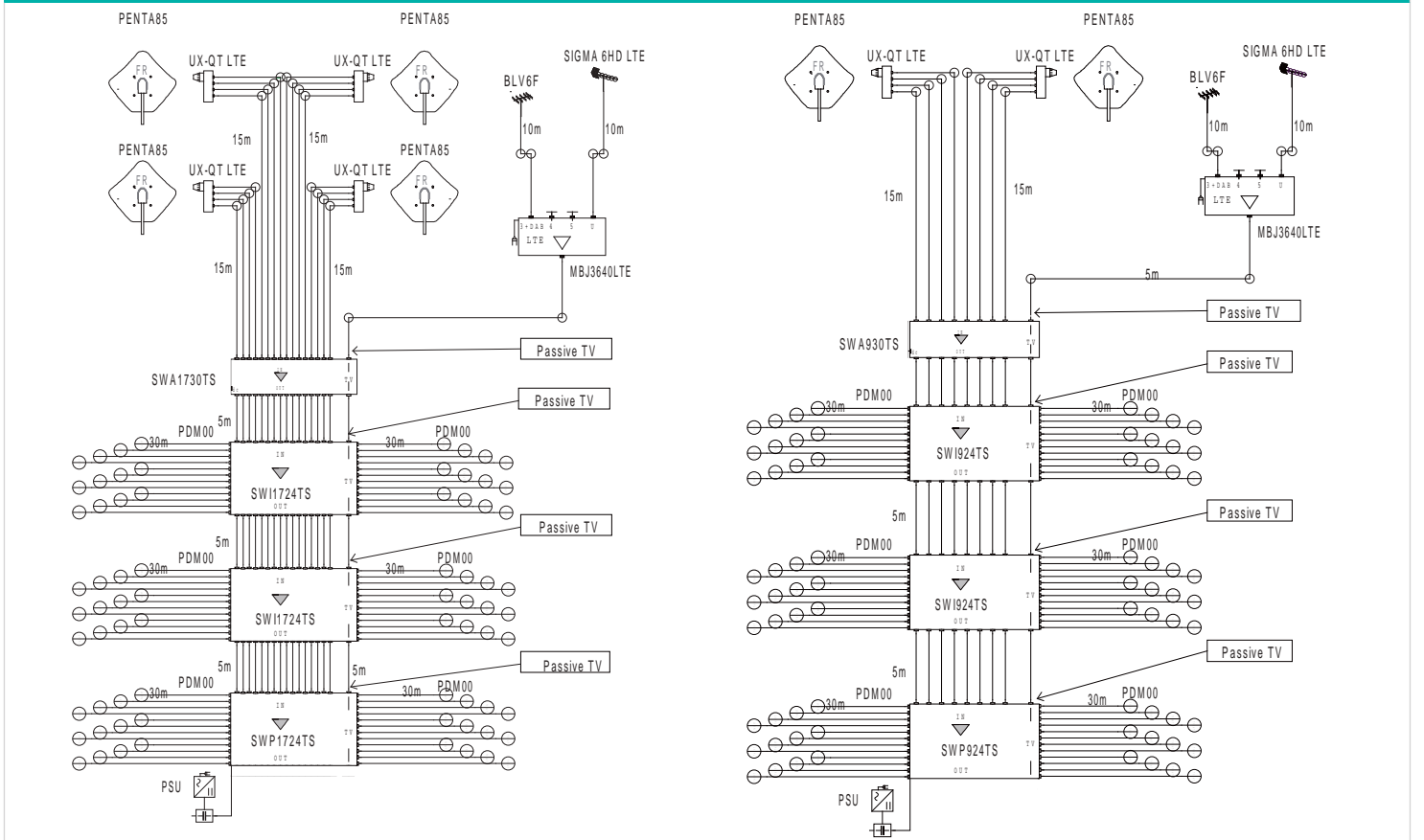

Multiswitches

Power supplies



AMP2000/UK

Power Supply with F connector DC inserter

- 14Vcc 2A
- Removable plug, with CVMS-EU it is possible to have European power cable and plug



PSU3001, PSU3001/UK

Power Supply with 2 F connector DC inserters

- 18Vcc 3A (1,5A for each output)
- On PSU3001, with PC8338 it is possible to adapt European cable to UK plugs
- It has 2 power inserter to divide current load on 2 different lines with 2 independent overload protections with 1.5A threshold. If this limit is not respected, an internal electronic control will suspend power generation and it will cyclically try to restore it until failure solution and normal condition reactivation



SPS1750

Power Supply with F connector DC inserter

- 15Vcc 1A
- With PC8338 it is possible to adapt European cable to UK plugs



PSU1315TS

Power supply with M-Type jack plug

- 13Vcc 1,5A
- With PC8338 it is possible to adapt European cable to UK plugs



PSU1340TS

Power supply with M-Type jack plug

- 13Vcc 4A
- With PC8338 it is possible to adapt European cable to UK plugs

Item		AMP2000/UK	PSU3001	PSU3001/UK	SPS1750	PSU1315TS	PSU1340TS
Code		271140	271160	271159	289087	287375	287376
Inputs	No.	1	2	2	1	-	-
Outputs	No.	1	2	2	1	-	-
Bandwidth	MHz	5-2400	5-2400	5-2400	40-2150	-	-
Insertion Loss	dB	-1,5	-1,5	-1,5	-1	-	-
Output Voltage	V	14	18	18	15	13	13
Output Current	mA	2.000	1.500 x2	1.500 x2	1.000	1.500	4.000
DC Plug	Type	F	F x2	F x2	F	M-Type Jack 2.1x5.5x12	M-Type Jack 2.1x5.5x12
Polarity					Internal positive, External negative IMMAGINE POLI		
Mains Voltage	V, Hz	220-240, 50-60	220-240, 50-60	220-240, 50-60	220-240, 50-60	120-240, 50-60	120-240, 50-60
Mains Plug		UK	European	UK	European	European	European
Isolation	Class	II					
Dimensions (l x h x w)	mm	185x100x60	165x63x107	165x63x107	40x70x90	90x70x45	110x52x34
Operating temperature	°C	-10 to 55	-10 to 55	-10 to 55	-10 to 55	0 ÷ 40	0 ÷ 40

Installation Example

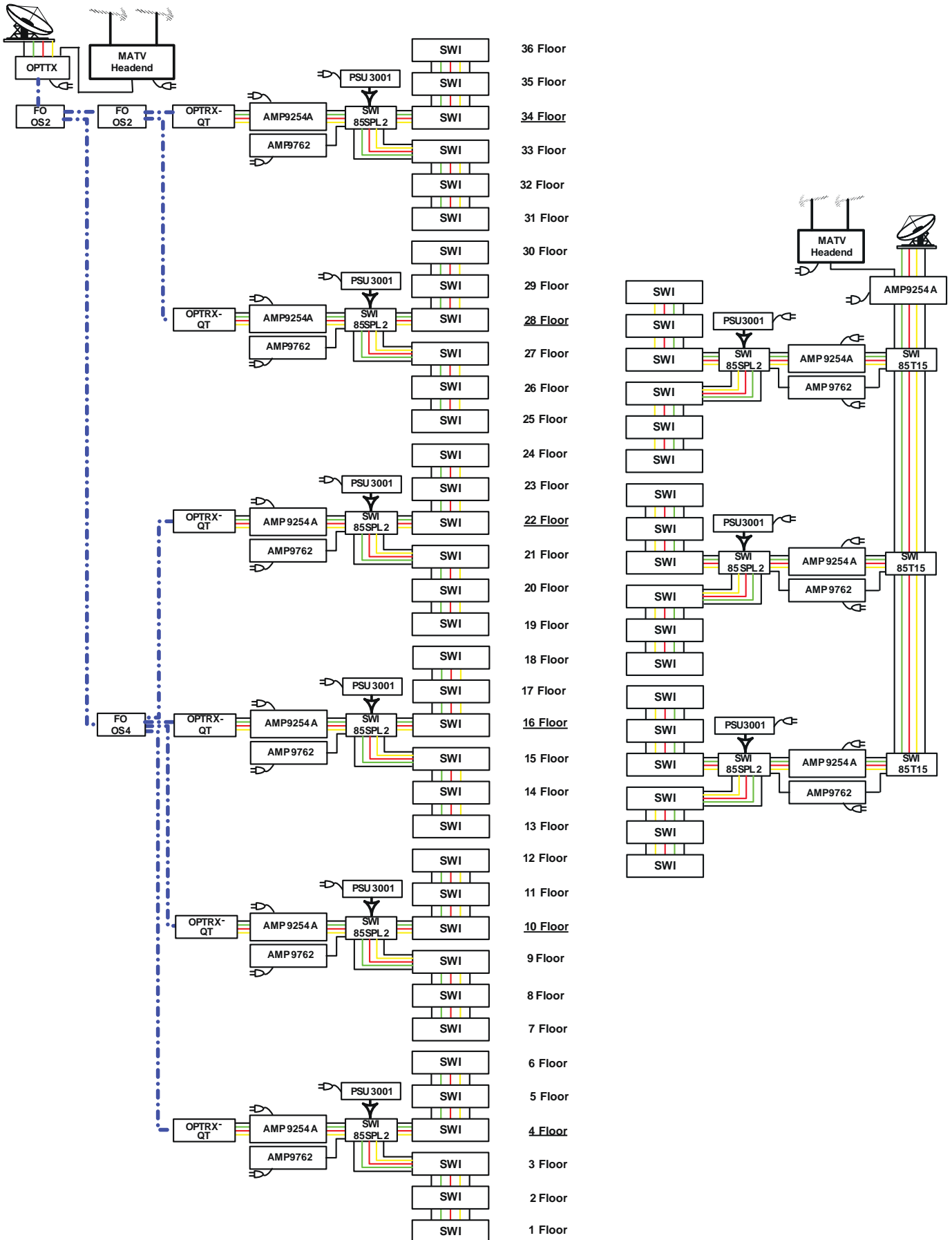

Multiswitches

Accessories



SWI44SP2

4 inputs satellite passive splitter

- Mainly used with 4 input multiswitches for satellite signal distribution
- Composed by 4 IF 2-way splitters in the same housing
- DC Pass from outputs to inputs on each SAT line
- Additional plastic bracket and standard colour coding for easy installation
- Compact size
- Cost effective



SWI44T15

4 inputs satellite passive tap

- Mainly used with 4 input multiswitches for satellite signal distribution
- Composed by 4 IF 1-way taps in the same housing
- Low insertion loss on trunk path
- DC Pass on each SAT line
- Additional plastic bracket and standard colour coding for easy installation
- Compact size
- Cost effective



SWI85SPL2

5 inputs satellite and terrestrial passive splitter

- Mainly used with 5 input multiswitches for SAT and TV signal distribution
- Composed by 4 IF 2-way splitters and 1 TV 2-way splitter in the same housing
- DC Pass on each SAT line in both directions
- Additional F DC connector to insert an external power supply
- Standard colour coding for easy installation



SWI85T15

5 inputs satellite and terrestrial passive tap

- Mainly used with 5 input multiswitches for SAT and TV signal distribution
- Composed by 4 IF 1-way taps and 1 TV 1-way tap in the same housing
- Low insertion loss on trunk path
- DC Pass on each SAT line
- Additional F DC connector to insert an external power supply
- Standard colour coding for easy installation



SWI39AT

5 inputs satellite and terrestrial active tap

- Mainly used with 9 input multiswitches for SAT and TV active signal distribution
- TV and SAT tap gain adjustment
- Very High TV and SAT output level
- Low insertion loss on trunk path
- Active return channel
- Powered through trunk lines
- DC Pass on HL, VH and HH trunk lines
- Standard colour coding for easy installation

Item			SWI44SP2	SWI44T15	SWI85SPL2	SWI85T15	SWI39AT
Code			271091	271092	271096	271095	271020
Inputs		No.	4 SAT	4 SAT	4 SAT, 1 TV, 1 DC	4 SAT, 1 TV	8 SAT, 1 TV
Outputs			4 SAT	4 SAT	4 SAT, 1 TV	4 SAT, 1 TV	8 SAT, 1 TV
Taps			4 SAT	4 SAT	4 SAT, 1 TV	4 SAT, 1 TV, 1 DC	8 SAT, 1 TV
SAT	Bandwidth	MHz	950-2150	950-2150	950-2150	950-2150	950-2150
	Gain	dB	-	-16 to -13	-	-13	-1
	Gain adjustment	dB	-	-	-	-	15
	Max. output level (-35dBc 2 ton.)	dB μ V	-	-	-	-	116
	Insertion Loss	dB	-4.5	-1	-4.5	-2	-1.5
TV	Bandwidth	MHz	-	-	5-862	5-862	85-862
	Gain	dB	-	-	-4.5	-13	10 to 15
	Gain adjustment	dB	-	-	-	-2	15
	Max. output level (-35dBc 2 ton.)	dB μ V	-	-	-	-	120
	Insertion Loss	dB	-	-	-	-	-1.5
Return path	Bandwidth	MHz	-	-	-	-	5-65
	Gain	dB	-	-	-	-	12
	Gain adjustment	dB	-	-	-	-	106
	Max. output level (-35dBc 2 ton.)	dB μ V	-	-	-	-	-1.5
Isolation SAT-SAT		dB				≥ 30	
Power supply		V	-	-	-	-	14-18
Power consumption		mA, V	-	-	-	-	320, 14V
Dimensions (l x h x w)		mm	90x70x20	90x70x20	160x118x30	160x118x30	170x140x60
Operating temperature		°C				-10 to 55	

Installation Example

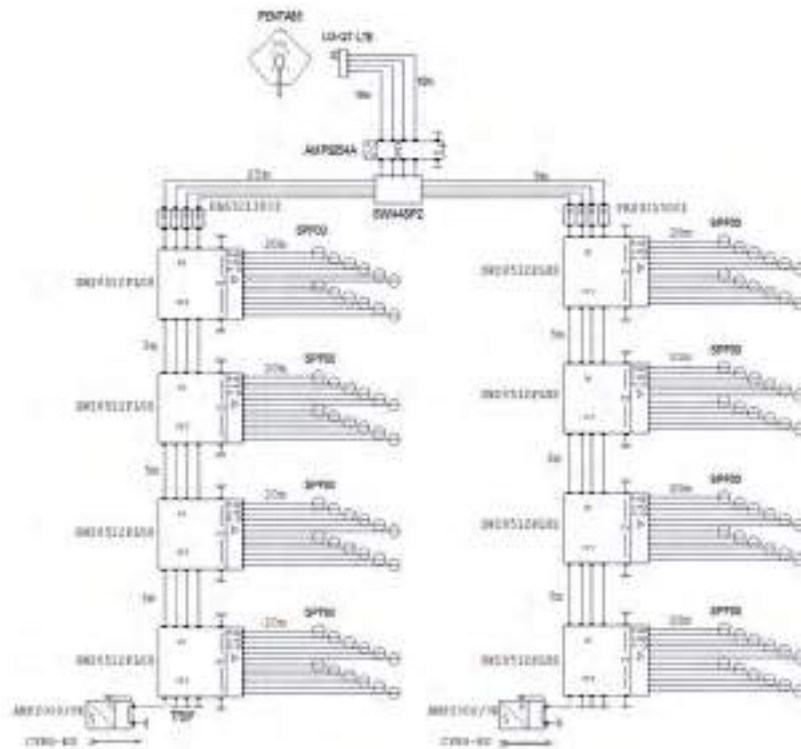

Multiswitches

Accessories

Mini DiSEqC

With SWI8508PLUS, SWI8512PLUS and SWI8516PLUS, the Mini DiSEqC and Tool Kit SWM1305A (code 271000) it is possible to distribute up to 4 satellites (16 polarities) + TV



Item		SWI1401B	
Code		271072	
Inputs	No.	4 (1 with TV mix)	
Inputs	A	SAT + TV	
Inputs	B	SAT	
Inputs	C	SAT	
Inputs	D	SAT	
Inputs	E	-	
Output	No.	1	
SAT	Bandwidth	MHz	950-2150
	Insertion loss	dB	1.5
TV	Bandwidth	MHz	5-862
	Insertion loss	dB	1.5
Power consumption	mA	25	
Dimensions (l x h x w)	mm	155x55x45	
Operating Temperature	°C	-10 to 55	

Accessories



Item	code	Description	Pcs
CVMS-EU	280005	Power cable with European plug to be used with SWI95../UK switches and AMP2000/UK power supply. Cable length 1.6m. Available in individual or multiple packaging (10 pcs).	1
PC8338	287398	Euro to UK converter	1
SCP3	287399	Earthed SCHUKO to UK converter	1
FEB	287203	Compression F connector for multiswitch earth bounding	1

Distribution

Clamp distribution components	
5-2400 MHz	132
SI Series	133
Accessories	133
Saddle and clamp distribution components	134
Vertical splitters with F connectors 5-2400 MHz	135
Vertical taps with F connectors 5-2400 MHz	136
Splitters with F connectors 5-2400 MHz	137
Taps with F connectors 5-2400 MHz	137
5-2400 MHz outlets	
SPL.. and SPF.. Series	139
PDM.. Series	140
Adaptors for outlets	141
Wall outlets TV+SAT	143
Cable connectors	144
Accessories	143
Coaxial cables	147
Coaxial cables Class A+	148
Coaxial cables Class A	149
Multicoaxial cables Class A	150

Distribution

Clamp distribution components

5-2400MHz

To complete the Fracarro range of distribution components the range called CAD S has been designed. Their patented features make them reliable and easy to install. They guarantee superb shielding (class A) and excellent impedance matching. CAD S splitters and taps development project and are one of-a-kind with a UBB input to allow single cable connection.



Item			PP2	PP3	PP4	PP5
Code			220802	220803	220804	220805
Splitters			2 way	3 way	4 way	5 way
Insertion loss dB	RC	5-40 MHz	4	6.5	9.5	11
	TV	47-862 MHz	4	6.5	9.5	11
	SAT	950-1750 MHz	4.5	6.5	10	11.5
	SAT	1750-2150 MHz	5	7	10.5	12
	SAT	2150-2400 MHz	5.5	8	11	13
Output-output isolation dB	RC	5-40 MHz	25	20	20	20
	TV	47-862MHz	22	20	25	25
	SAT	950-1750 MHz	20	20	25	25
	SAT	1750-2150 MHz	20	20	20	22
	SAT	2150-2400 MHz	18	18	18	18

Item			CD1-10	CD1-14	CD1-18	CD1-22
Code			220810	220814	220818	220822
Taps			1	1	1	1
Insertion loss dB	RC	5-40 MHz	1.8	0.8	0.8	0.8
	TV	47-862 MHz	1.6	0.8	0.8	0.8
	SAT	950-1750 MHz	2	1.3	1.3	1.3
	SAT	1750-2150 MHz	2.3	1.5	1.5	1.5
	SAT	2150-2400 MHz	2.6	2	2	2
Tap loss dB	RC	5-40 MHz	10	14.5	18	22
	TV	47-862 MHz	10	14.5	18	22
	SAT	950-1750 MHz	10	14.5	17.5	21.5
	SAT	1750-2150 MHz	10	14.5	18	22
	SAT	2150-2400 MHz	10	14	18	22
Output-output isolation dB	RC	5-40 MHz	28	30	32	36
	TV	47-862MHz	30	33	35	40
	SAT	950-1750 MHz	30	25	30	35
	SAT	1750-2150 MHz	28	25	27	30
	SAT	2150-2400 MHz	32	24	24	27

Item			CD2-10	CD2-14	CD2-18	CD2-22
Code			220830	220834	220838	220842
Taps			2	2	2	2
Insertion loss dB	RC	5-40 MHz	3.5	1.6	2.6	1.6
	TV	47-862 MHz	3	1.5	1.5	1.5
	SAT	950-1750 MHz	3.3	2.5	2.5	2.5
	SAT	1750-2150 MHz	4.2	2.7	2.7	2.7
	SAT	2150-2400 MHz	4.7	3.5	3.5	3.5
Tap loss dB	RC	5-40 MHz	11	15	18	22
	TV	47-862 MHz	10	15	18	22
	SAT	950-1750 MHz	10.5	14.5	18	22
	SAT	1750-2150 MHz	10.5	14.5	18	22
	SAT	2150-2400 MHz	11	14.5	18	22
Output-output isolation dB	RC	5-40 MHz	25	30	32	35
	TV	47-862 MHz	28	35	37	40
	SAT	950-1750 MHz	23	25	28	32
	SAT	1750-2150 MHz	20	23	26	30
	SAT	2150-2400 MHz	18	23	26	30



Item			CD4-12	CD4-14	CD4-18
Code			220852	220854	220858
Taps			4	4	4
Insertion loss dB	RC	5-40 MHz	4	3.5	1.6
	TV	47-862 MHz	3.7	3.3	1.5
	SAT	950-1750 MHz	4.5	3.7	2.5
	SAT	1750-2150 MHz	5.5	4.5	3.5
	SAT	2150-2400 MHz	6.5	5	4
Tap loss dB	RC	5-40 MHz	13	14	19
	TV	47-862 MHz	12	14	18
	SAT	950-1750 MHz	12	14.5	18
	SAT	1750-2150 MHz	12.5	14.5	18
	SAT	2150-2400 MHz	13	14.5	18
Output-output isolation dB	RC	5-40 MHz	27	30	33
	TV	47-862 MHz	27	30	35
	SAT	950-1750 MHz	27	30	33
	SAT	1750-2150 MHz	25	25	30
	SAT	2150-2400 MHz	25	25	25

Clamp distribution components

SI Series

Indoor clamp distribution components

Item	Code	Description	Pcs
SI2	220872	2-way clamp splitter, 5-2400MHz, CAD-S series. plastic housing. (PP2+BIC)	1
SI3	220873	3-way clamp splitter, 5-2400MHz, CAD-S series. plastic housing (PP3+BIC)	1
SI4	220874	4-way clamp splitter, 5-2400MHz, CAD-S series. plastic housing (PP4+BIC)	1

Accessories

CADS boxes

Indoor and outdoor boxes for CAD S .

Item	Code	Description	Pcs
BIC	220800	Indoor box for CAD S	20
BOC	220801	Outdoor box for CAD S	1
ARD	220891	Din rail adaptor for CAD S	10

Distribution

Saddle and clamp distribution components

47-862MHz

Fully shielded metal housing screw and saddle clamp splitters. It is not advisable to feed the output sockets directly because of the low separation. Socket should be connected to a tap output. One input - several outputs. V.S.W.R. <1.2



Item		PP12	PP13	PP14
Code		220370	220376	220390
No. of outputs		2	3	4
Attenuation dB	input and output	4	6	7
	between two outputs	18	15	10
Pcs		10	10	10

Item		PP12DC	PP14DC	IP2
Code		220375	220392	220322
No. of outputs		2	4	2
Attenuation dB	input and output	4	8	4
	between two outputs	18	10	18
Pcs		10	10	10

Saddle and clamp distribution components

47-862MHz

Fully shielded metal housing screw and saddle clamp taps. 1 input, 1 through-line output, 1 or more tapped outputs. Suitable for through-line or as terminal as well, by fit-ting a resistive load CR75I.



Item		CD11	CD12	CD144	
Code		220660	220670	220654	
N° Output		1	2	4	
Insertion loss dB	min.	0.8	1.3	0.8	
	max.	1.1	1.8	2.8	
Output-tap isolation dB	Bands	1	10	16	
		3	10	16	
		4	10	15	
		5	10	15	
		Isolation between outputs dB	Bands	1	-
		3	-	21	16/27
		4	-	19	18/35
		5	-	19	18/40
V.S.W.R Input		<1.2	<1.4	<1.5	

Saddle and clamp distribution components

47-862MHz

Directional taps with fixed separation from the main line for all frequencies.



Item		CAD11	CAD12	CAD13	CAD14	
Code		220451	220452	220453	220454	
N° Output		1	2	3	4	
Insertion loss dB	min.	0.1	0.1	0.2	0.1	
	max.	0.7	0.8	2	1.9	
Output-tap isolation dB	Bands	1	27	27	27	
		3	17	18	17	
		4	11	12	12	
		5	12	13	15	
		Isolation between outputs dB	Bands	1	45	53
		3	38	43	35/30	37/60
		4	36	30	34/25	29/52
		5	35	26	32/35	25/45
V.S.W.R Input		<1.1	<1.2	<1.3	<1.2	

**Vertical splitters with F connectors
5-2400MHz**

New CATV splitters on frequency range 5-2400MHz with "vertical" F connectors. Compact and good-looking design to fulfil every installation requirement and enable them to be installed in every location. Nickel plated housing allows to reach the best performances over all the operating frequency range, with low insertion loss up to high frequencies and high isolation between outputs. DC pass is allowed between every output and input.



Key points:

- Low insertion loss also on SAT band, up to 2400MHz.
- Changeless attenuation on output ports from 5 to 2400MHz.
- DC pass from outputs to input
- High return loss
- "A" shielding factor
- 1 earthing screw
- Wall fixing

Item			PA2	PA3	PA4
Code			280701	280703	280702
Outputs			2	3	4
Insertion loss	5-40 MHz	dB	4	7	7.5
	40-470 MHz	dB	4	8	8.5
	470-1000 MHz	dB	4.5	8	9
	1000-1750 MHz	dB	5.5	10	11
	1750-2050 MHz	dB	5.5	10.5	11.5
	2050-2400 MHz	dB	6	11	12
Separation Out-Out	5-40 MHz	dB	22	22	30
	40-470 MHz	dB	22	22	30
	470-1000 MHz	dB	20	22	25
	1000-1750 MHz	dB	20	22	26
	1750-2050 MHz	dB	20	22	22
	2050-2400 MHz	dB	23	22	22

Item			PA6	PA8
Code			280704	280705
Outputs			6	8
Insertion loss	5-40 MHz	dB	10.5	12
	40-470 MHz	dB	10.5	12
	470-1000 MHz	dB	12	13.5
	1000-1750 MHz	dB	13.5	15.5
	1750-2050 MHz	dB	14.5	16.5
	2050-2400 MHz	dB	16	17
Separation Out-Out	5-40 MHz	dB	22	20
	40-470 MHz	dB	22	20
	470-1000 MHz	dB	22	20
	1000-1750 MHz	dB	22	20
	1750-2050 MHz	dB	22	20
	2050-2400 MHz	dB	22	20

**Vertical taps with F connectors
5-2400MHz**

New CATV taps on frequency range 5-2400MHz with "vertical" F connectors. Compact and good-looking design to fulfil every installation requirement and enable them to be installed in every location. Nickel plated housing allows to reach the best performances over all the operating frequency range, with low insertion loss up to high frequencies and high isolation between outputs. DC pass is allowed between the loop-through output and input.

Item			DE1-10	DE1-14	DE1-18	DE1-22
Code			280710	280711	280712	280713
Taps			1	1	1	1
Insertion loss	5-40 MHz	dB	1.5	1	0.8	0.6
	40-470 MHz	dB	1.3	0.8	0.7	0.6
	470-1000 MHz	dB	1.3	0.8	0.7	0.5
	1000-1750 MHz	dB	1.6	1.2	0.9	0.8
	1750-2050 MHz	dB	2	1.3	1	1
	2050-2400 MHz	dB	2	1.5	1.3	1.7
Tap loss	5 - 2400 MHz	dB	10	14	18	22
Separation Out-Out	5-40 MHz	dB	40	32	45	50
	40-470 MHz	dB	35	29	36	38
	470-1000 MHz	dB	32	28	31	33
	1000-1750 MHz	dB	27	28	31	33
	1750-2050 MHz	dB	24	30	27	31
	2050-2400 MHz	dB	24	25	22	27

Distribution

Vertical taps with F connectors 5-2400MHz



Key points:

- Low insertion loss also on SAT band, up to 2400MHz.
- Changeless attenuation on output ports from 5 to 2400MHz.
- DC pass from outputs to input
- High return loss
- "A" shielding factor
- 1 earthing screw
- Wall fixing

Item			DE2-10	DE2-14	DE2-18	DE2-22
Code			280714	280715	280716	280717
Taps			2	2	2	2
Insertion loss	5-40 MHz	dB	2.5	1.5	1.2	1.2
	40-470 MHz	dB	2.5	1.5	1.2	1.2
	470-1000 MHz	dB	2.5	1.5	1.2	1.1
	1000-1750 MHz	dB	2.5	1.8	1.5	1.5
	1750-2050 MHz	dB	2.8	2	1.8	1.8
	2050-2400 MHz	dB	3.5	2.2	2	2.2
Tap loss			10	14	18	22
Separation Out-Out	5-40 MHz	dB	25	35	45	45
	40-470 MHz	dB	28	29	35	40
	470-1000 MHz	dB	28	25	30	35
	1000-1750 MHz	dB	25	25	27	31
	1750-2050 MHz	dB	25	23	27	27
	2050-2400 MHz	dB	23	23	25	27

Item			DE4-12	DE4-14	DE4-18	DE4-22
Code			280718	280719	280720	280721
Taps			4	4	4	4
Insertion loss	5-40 MHz	dB	3.5	2.5	1.5	1
	40-470 MHz	dB	3.5	2.3	1.3	1
	470-1000 MHz	dB	4.3	2.5	1.3	1
	1000-1750 MHz	dB	5.1	3	1.5	1.2
	1750-2050 MHz	dB	5.2	3.5	1.8	1.5
	2050-2400 MHz	dB	5.4	4	2	1.5
Tap loss			12	14	18	22
Separation Out-Out	5-40 MHz	dB	35	32	45	38
	40-470 MHz	dB	35	32	45	37
	470-1000 MHz	dB	35	35	45	33
	1000-1750 MHz	dB	28	30	35	31
	1750-2050 MHz	dB	28	27	30	27
	2050-2400 MHz	dB	28	30	30	26

Item			DE6-16	DE6-20	DE8-16	DE8-20
Code			280722	280723	280725	280726
Taps			6	6	8	8
Insertion loss	5-40 MHz	dB	4.5	2.5	4.5	30
	40-470 MHz	dB	5	3	5	25
	470-1000 MHz	dB	5	3	5	25
	1000-1750 MHz	dB	5.5	4	5.5	25
	1750-2050 MHz	dB	5.5	4.5	5.5	25
	2050-2400MHz	dB	5.5	5.5	5.5	25
Tap loss			16	20	16	20
Separation Out-Out	5-40 MHz	dB	25	30	2.5	30
	40-470 MHz	dB	22	25	2.5	25
	470-1000 MHz	dB	22	22	3.5	20
	1000-1750 MHz	dB	22	22	4.5	20
	1750-2050 MHz	dB	22	22	5	20
	2050-2400 MHz	dB	22	22	5.5	20

**Splitters with F connectors
5-2400MHz**

SPTR

New CATV splitters on frequency range 5-2400MHz with "top down" F connectors. Compact and good-looking design to fulfil every installation requirement and enable them to be installed in every location. Zinc die cast housing allows to reach the best performances over all the operating frequency range, with low insertion loss up to high frequencies and high isolation between outputs. DC pass is allowed between every output and input.



Key points:

- Low insertion loss also on SAT band, up to 2400MHz.
- Changeless attenuation on output ports from 5 to 2400MHz.
- DC pass from outputs to input
- High return loss
- "A" shielding factor
- 2 earthing screws
- Wall fixing

Item			SPTR2	SPTR3	SPTR4
Code			287305	287307	287306
Insertion loss	40 MHz	dB	3.5	6	7
	862 MHz	dB	4	7	8
	950 MHz	dB	4	7	8
	2150 MHz	dB	5	9	9.5
	2400 MHz	dB	5.5	9.5	10
Separation Out-Out	40 MHz	dB	27.5	0.25	20
	862 MHz	dB	20	20	20
	950 MHz	dB	20	20	20
	2150 MHz	dB	18	20	18
	2400 MHz	dB	18	18	18
Dimensions		mm	112x127x64	112x127x64	155x127x64

Item			SPTR6	SPTR8
Code			287308	287309
Insertion loss	40 MHz	dB	10	11
	862 MHz	dB	11	12.5
	950 MHz	dB	11.5	12.5
	2150 MHz	dB	14.5	15.5
	2400 MHz	dB	16	16
Separation Out-Out	40 MHz	dB	27.5	27.5
	862 MHz	dB	25	25
	950 MHz	dB	25	25
	2150 MHz	dB	25	25
	2400 MHz	dB	25	25
Dimensions		mm	122x254x64	122x254x64

**Taps with F connectors
5-2400MHz**

TAPS

New CATV taps on frequency range 5-2400MHz with "top down" F connectors. Compact and good-looking design to fulfil every installation requirement and enable them to be installed in every location. Zinc die cast housing allows to reach the best performances over all the operating frequency range, with low insertion loss up to high frequencies and high isolation between outputs. DC pass is allowed between the loop-through output and input.

Item			TAPS110	TAPS115	TAPS120
Code			287310	287311	287312
Taps			1	1	1
Insertion loss	40 MHz	dB	2	1.5	1
	862 MHz	dB	2	1.5	1
	950 MHz	dB	2.5	2	1.5
	2150 MHz	dB	3	2.5	2
	2400 MHz	dB	3.5	3	2.5
Tap loss	40 ÷ 2400 MHz	dB	10	15	20
Separation Out-Out	40 MHz	dB	28	35	39
	862 MHz	dB	24	26	29
	950 MHz	dB	23	25	25
	2150 MHz	dB	22	23	25
	2400 MHz	dB	22	23	25
Dimensions		mm	55x64x27		

Distribution

Taps with F connectors 5-2400MHz



Key points:

- Low insertion loss also on SAT band, up to 2400MHz.
- Changeless attenuation on tap ports from 5 to 2400MHz.
- DC pass from loop-through output to input
- High separation between outputs
- "A" shielding factor
- 2 earthing screws
- Wall fixing

Item			TAPS212	TAPS215	TAPS220
Code			287313	287314	287315
Taps			2	2	2
Insertion loss	40 MHz	dB	3	2	1.5
	862 MHz	dB	3	2.5	2
	950 MHz	dB	3.5	3.5	3
	2150 MHz	dB	4	3.5	3
	2400 MHz	dB	5	4	4
Tap loss	40 ÷ 2400 MHz	dB	12	15	20
Separation Out-Out	40 MHz	dB	25	30	33
	862 MHz	dB	25	30	30
	950 MHz	dB	25	27	28
	2150 MHz	dB	22	25	28
	2400 MHz	dB	21	25	25
Dimensions		mm	55x64x27		

Item			TAPS412	TAPS415	TAPS420
Code			287316	287317	2287318
Taps			4	4	4
Insertion loss	40 MHz	dB	2.5	2.5	2
	862 MHz	dB	3	2.5	2
	950 MHz	dB	3	2.5	2
	2150 MHz	dB	3.5	3	3
	2400 MHz	dB	4	4	3.5
Tap loss	40 ÷ 2400 MHz	dB	12	15	20
Separation Out-Out	40 MHz	dB	28	30	33
	862 MHz	dB	24	25	28
	950 MHz	dB	23	24	26
	2150 MHz	dB	22	23	24
	2400 MHz	dB	22	22	23
Dimensions		mm	84x64x27		

Item			TAPS616	TAPS620
Code			287319	287320
Taps			6	6
Insertion loss	40 MHz	dB	4	2.5
	862 MHz	dB	4.5	2.5
	950 MHz	dB	5	3
	2150 MHz	dB	5.5	4.5
	2400 MHz	dB	7	5.5
Tap loss	40 ÷ 2400 MHz	dB	16	20
Separation Out-Out	40 MHz	dB	25	24
	862 MHz	dB	25	24
	950 MHz	dB	24	24
	2150 MHz	dB	22	22
	2400 MHz	dB	21	21
Dimensions		mm	126x64x27	

Item			TAPS816	TAPS820
Code			287321	287322
Taps			8	8
Insertion loss	40 MHz	dB	4.5	2.5
	862 MHz	dB	5	3
	950 MHz	dB	5.5	3
	2150 MHz	dB	5.5	4.5
	2400 MHz	dB	7	5.5
Tap loss	40 ÷ 2400 MHz	dB	16	20
Separation Out-Out	40 MHz	dB	23	24
	862 MHz	dB	23	23
	950 MHz	dB	22	23
	2150 MHz	dB	21	22
	2400 MHz	dB	20	21
Dimensions		mm	126x64x27	

5-2400MHz outlets

SPI.. and SPF.. Series

Single outlets 5-2400MHz. High screening efficiency to standard EN 50083-4 Class A. The outlet is designed with an innovative system to connect to coaxial cable. It enables the user to connect to a cable with a diameter between 5 and 7mm. Terminal outlets allow the current to pass through the input and user output. Pass-through outlets allow the current to pass through input and output and blocks it on user output.



Item				SPI00	SPI05	SPI10
Code				220711	220712	220713
Insertion loss	Return path	5-40MHz	dB	—	< 5	< 2.5
		TV	47-862 MHz	dB	—	< 5
	SAT	950-2150 MHz	dB	—	< 7	< 3
		2150-2400 MHz	dB	—	< 8	< 3.2
Insertion loss	Return path	5-40MHz	dB	< 0.5	< 5	10.5
		TV	47-862 MHz	dB	< 0.5	< 5
	SAT	950-2150 MHz	dB	< 0.8	< 7	10.5
		2150-2400 MHz	dB	< 0.8	< 8	11
Outlet type				Terminal	Pass-through	
Connector				IEC male		

Item				SPI14	SPI18	SPI22
Code				220714	220715	220716
Insertion loss	Return path	5-40MHz	dB	< 1.5	< 1.5	< 1.5
		TV	47-862 MHz	dB	< 1.2	< 1.2
	SAT	950-2150 MHz	dB	< 2.2	< 2.2	< 2.2
		2150-2400 MHz	dB	< 2.5	< 2.5	< 2.5
Insertion loss	Return path	5-40MHz	dB	15	18.5	22.5
		TV	47-862 MHz	dB	14.5	18
	SAT	950-2150 MHz	dB	14.5	18	22
		2150-2400 MHz	dB	15	18.5	22.5
Outlet type				Pass-through		
Connector				IEC male		

Distribution



Item				SPF00	SPF05	SPF10
Code				220721	220722	220723
Insertion loss	Return path	5-40MHz	dB	—	< 5	< 2.5
		47-862 MHz	dB	—	< 5	< 2.5
	TV	950-2150 MHz	dB	—	< 7	< 3
		2150-2400 MHz	dB	—	< 8	< 3.2
Insertion loss	Return path	5-40MHz	dB	< 0.5	< 5	10.5
		47-862 MHz	dB	< 0.5	< 5	10
	SAT	950-2150 MHz	dB	< 0.8	< 7	10.5
		2150-2400 MHz	dB	< 0.8	< 8	11
Outlet type				Terminal	Pass-through	
Connector				F female		

Item				SPF14	SPF18	SPF22
Code				220724	220725	220726
Insertion loss	Return path	5-40MHz	dB	< 1.5	< 1.5	< 1.5
		47-862 MHz	dB	< 1.2	< 1.2	< 1.2
	TV	950-2150 MHz	dB	< 2.2	< 2.2	< 2.2
		2150-2400 MHz	dB	< 2.5	< 2.5	< 2.5
Insertion loss	Return path	5-40MHz	dB	15	18.5	22.5
		47-862 MHz	dB	14.5	18	22
	SAT	950-2150 MHz	dB	14.5	18	22
		2150-2400 MHz	dB	15	18.5	22.5
Outlet type				Pass-through		
Connector				F female		

5-2400MHz outlets

PDM.. Series

Demix outlets allow the user to split, via two different connectors, TV-SAT signals (5-2400MHz). They have a clamp connection to insert the cable. It enables the user to connect a cable with a diameter between 5 and 7mm. This range of outlets allow the current to pass through the input and user SAT output. It is a special pass-through outlet and for this reason the last outlet has been closed with an isolated 75 Ohm load.

Item				PDM00	PDM05	PDM10
Code				220003	220002	220001
Insertion loss	TV	47-862 MHz	dB	—	< 6.0	< 4.0
	SAT	950-2400 MHz	dB	—	< 6.0	< 4.0
Distribution loss	TV	47-862 MHz	dB	< 2	< 6	10
	TSAT	950-2400 MHz	dB	< 2	< 6	11
Pack.			Pcs	10		
Connector				Terminal	Pass-through	



Item				PDM14	PDM18	PDM22
Code				220004	220005	220006
Insertion loss	TV	47-862 MHz	dB	< 3	< 2.5	< 2.5
	SAT	950-2400 MHz	dB	< 3.5	< 3.5	< 3.5
Distribution loss	TV	47-862 MHz	dB	14	19	22
	TSAT	950-2400 MHz	dB	15	19	23
Pack.				Pcs	10	
Connector				Pass-through		

Adaptors for outlets

SPI..., SPF..., and PDM.. Series



Item	Code	Adaptors	Colour	Type	Packaging Pcs
BT-AX	287126	Ticino Axolute ®	White	Single	20
BT-AX2	287127			Demix	10
BT-AXS	289737	Ticino Axolute Silver ®	Silver	Single	20
BT-AXS2	289739			Demix	10
BT-AXB	289738	Ticino Axolute Black ®	Black	Single	20
BT-AXB2	289740			Demix	10
BT-INT	280754	Ticino International ®	Black	Single	20
BT-INT2	280801			Demix	10
BT-LIG	280752	Ticino Light ®	Ice	Single	20
BT-LIG2	280802			Demix	10
BT-LIGT	280699	Ticino Light Tech ®	Dark grey	Single	20
BT-LIGT2	280803			Demix	10
BT-MA	280755	Ticino Magic ®	Ivory	Single	20
BT-MA2	280804			Demix	10
BT-LIV	280753	Ticino Living ®	Black	Single	20
BT-LIV2	280805			Demix	10
BT-LU	280756	Ticino Luna ®	White	Single	20
BT-LU2	280806			Demix	10
BT-MAT	280757	Ticino Matix ®	White	Single	20
BT-MAT2	280807			Demix	10
BT-TT	280742	Ticino Magic TT ®	Ivory	Single	20
BT-MATT2	280808			Demix	10
VI-EKN	289798	Vimar Eikon Next ®	Dark grey	Single	20
VI-EKN2	289799			Demix	10
VI-EKW	280839	Vimar Eikon White ®	White	Single	20
VI-EKW2	280840			Demix	10
VI-EKB	289741	Vimar Eikon Black ®	Black	Single	20
VI-EKB2	289742			Demix	10
VI-ID	280749	Vimar Idea ®	Black	Single	20
VI-ID2	280810			Demix	10
VI-IDB	280748	Vimar Idea Bianca ®	White	Single	20
VI-IDB2	280811			Demix	10
VI-80	280750	Vimar 8000 ®	Ivory	Single	20
VI-802	280809			Demix	10

Distribution



VI-PL	280751	Vimar Plana ®	White	Single	20
VI-PL2	280812			Demix	10
VI-PLS	287121	Vimar Plana Silver ®	Silver	Single	20
VI-PLS2	287122			Demix	10
GW-CB	280837	Gewiss Chorus Bianco Lucido ®	Bright white	Single	20
GW-CB2	280838			Demix	10
GW-CN	280835	Gewiss Chorus Nero Satinato ®	Glossed black	Single	20
GW-CN2	280836			Demix	10
GW-CT	280833	Gewiss Chorus Titanio Verniciato ®	Varnished titanium	Single	20
GW-CT2	280834			Demix	10
GW-PL	280797	Gewiss Playbus ®	Black	Single	20
GW-PL2	280813			Demix	10
GW-SYB	280796	Gewiss System Black ®	Black	Single	20
GW-SYB2	280814			Demix	10
GW-SYW	280798	Gewiss System White ®	White	Single	20
GW-SYW2	280815			Demix	10
AB-CH	280831	ABB Chiara ®	White	Single	20
AB-CH2	280832			Demix	10
AV-SNO	280743	Ave Sistema 45 Noir ®	Black	Single	20
AV-SNO2	280816			Demix	10
AV-SBA	280745	Ave Sistema 45 Banquise ®	Ice	Single	20
AV-SBA2	280817			Demix	10
AV-SBL	280746	Ave Sistema 45 Blanc ®	White	Single	20
AV-SBL2	280818			Demix	10
LG-CR	280747	Legrand Cross ®	White	Single	20
LG-CR2	280820			Demix	10
LG-VES	280800	Legrand Vela Scura ®	Black	Single	20
LG-VES2	280821			Demix	10
LG-VEC	280799	Legrand Vela Chiara ®	Ice	Single	20
LG-VEC2	280822			Demix	10
VI-ARK-B	287331	Arke Black ®	Black	Single	20
VI-ARK2-B	287304			Demix	10
VI-ARK-W	287330	287303	White	Single	20
VI-ARK2-W	287303			Demix	10
PL1	280736	Cover for SPL. and SPF.. - For European boxes ø 60mm			50

Wall outlets TV + SAT

Wall outlets with TV and SAT outputs. One terminal version and 5 pass-through versions available: from 6dB loss up to 22dB loss.



Item		PRI00		PRI06		PRI10	
Code		280730		280731		280732	
Output		TV	SAT	TV	SAT	TV	SAT
Connector		IEC female	IEC male	IEC female	IEC male	IEC female	IEC male
Bandwith	MHz	5-40/47-862	950-2300	5-40/47-862	950-2300	5-40/47-862	950-2300
Tap loss	dB	-		6		10	
Insertion loss	dB	1.5	2	2	2.5	1.5	2
Outlet type		Terminal		Pass-through		Pass-through	
Dimensions	mm	76 x 76 x 32					

Item		PRI14		PRI18		PRI22	
Code		280733		280734		280735	
Output		TV	SAT	TV	SAT	TV	SAT
Connector		IEC female	IEC male	IEC female	IEC male	IEC female	IEC male
Bandwith	MHz	5-40/47-862	950-2300	5-40/47-862	950-2300	5-40/47-862	950-2300
Tap loss	dB	14		18		22	
Insertion loss	dB	1.5	2	1.5	2	1.5	2
Outlet type		Pass-through		Pass-through		Pass-through	
Dimensions	mm	76 x 76 x 32					

Item	Code	
PL2	280737	Cover
CAPL	280741	Box

Distribution

Wall outlets TV + SAT

Wall outlet family able to demix different signals coming from a single cable as return channel, TV and SAT bands.

Key points:

- High shielding.
- Easy and quick installation.
- Excellent separation between bands
- Low insertion loss.
- F female max current 500mA.



Item		PAS0042	PAS0042D	PAS0032	PAS00322
Code		PAS0042	280793	PAS0032	287103
TV Connector		IEC female	IEC female	IEC female	IEC female
R Connector		IEC male	IEC male	IEC male	IEC male
SAT1 Connector		F female	F female	F female	F female
SAT2 Connector		F female	F female		
TV Bandwith	MHz	5-68/ 120-862	5-68/ 260-862	5-68/120-862	5-862
R Bandwith	MHz	88-108	87-240	88-108	5-862
SAT1 Bandwith	MHz	950-2150	950-2150		
SAT2 Bandwith	MHz	5-2150	950-2150	950-2150	950-2300
Tap loss	dB	-	-	-	-
TV Insertion loss	dB	2.5	2.5	1.5	5
R Insertion loss	dB	2.5	2.5	2	5
SAT1 Insertion loss	dB	2	2.		
SAT2 Insertion loss	dB	3	3	2	3
Outlet type		Terminal	Terminal	Terminal	Terminal

Item		PAS0032D	PAS0023411	PAS0023311
Code		PAS0032D	PAS0023411	PAS0023311
TV Connector		IEC female	IEC female	IEC female
R Connector		IEC male	IEC male	IEC male
SAT Connector		F female		
TV Bandwith	MHz	5-68/ 260-862	5-68/ 120-862	88-108
R Bandwith	MHz	87-240	88/108	5-68/ 120-832
SAT Bandwith	MHz	950-2300	-	-
Tap loss	dB	-	14	11
TV Insertion loss	dB	1.5	1	1.5
R Insertion loss	dB	2	1	1.5
SAT Insertion loss	dB	2	-	-
Outlet type		Terminal	Pass-through	Pass-through

Cable connectors

I.E.C. connectors



Item	SPI		SP5	
Code	290351		290354	
Type	Male- straight		Male- straight	
Copper plated	screw	x		
	shielded			x
ø 9.5	mm	x	x	
Packaging	Pcs	100	100	

Item	PRI	PR5	PRI1	
Code	290451	290454	290365	
Type	Female-straight		Female-straight	
Copper plated	screw	x		
	shielded		x	x
ø 9.5	mm	x	x	x
Packaging	Pcs	100	50	50

Cable connectors

F connectors



Item	CF50B	CF60B	CF66B	CF70B
Code	287189	287190	287191	287192
Type	Quick F male			
Cables	ø mm 4.9-5.0	5.9-6.0	6.5-6.6	6.9-7.0
Ring colour	red	green	yellow	blue
Packaging	Pcs	100		

Item	CFR50B	CFR60B	CFR66B
Code	287193	287194	287195
Type	Plug-in F male		
Cables	ø mm 4.9-5.0	5.9-6.0	6.5-6.6
Ring colour	red	green	yellow
Packaging	Pcs	100	

Item	CCF66	CCF102
Code	289768	289769
Type	Ring crimping F male	
Cables	ø mm 6.5-6.6	10.2
Ring colour	yellow	grey
Packaging	Pcs 100	20

Item	CCOM F5.1	CCOM F5.1 S	CCOM F10.5
Code	287301	287295	287297
Type	Compression F male	Compression F male - self install	Compression F male
Cables	ø mm Dielectric 5.1	Dielectric 5.1	External 10.5
Ring colour	light blue	light blue	yellow
Packaging	Pcs 100	50	100

Distribution



Item		CCOM IEC6F	CCOM IEC6M
Code		287298	287300
		IEC Compression F female	IEC Compression F male
Cables	ø mm	Dielectric 6	Dielectric 6
Ring colour		light blue	light blue
Packaging	Pcs		100

Item		TCOM pocket	TCOM all size
Code		287296	287299
Description		Tool for cables RG59	Tool for all sizes
Dimension	mm	140x55x25	210x75x25
Packaging	Pcs	1	1

Accessories

75 Ohm loads



Item	code	Description	Pcs
CA75F	289085	Single load - F male connector	100
T75IF	290002	Isolated load - F male connector	20
CR75I	289776	Coaxial for TV	20
AR20F	287202	Adjustable attenuator	5
FEB	287203	Compression F connector for multiswitch earth bonding	10

ADAPTORS



Item	code	Description	Pcs
TF90	289543	Right angle F male to F female	50
GCF	289544	F female - F female	50
GC1	290030	Cable connector	100
PAUTV	280373	Dual F female - F female - F female grounding back	250
PAS32360	PAS32360	F male - F male quick	1
PAS3213001	PAS3213001	F female - F female with DC block	20
PAS6106	289770	5-2400MHz attenuator - Att. 6dB - DC pass	5

ACCESSORIES

Item	code	Description	Pcs
PRT1	210095	Earth terminal board - For earth connection of 6 coaxial cables in a TV distribution network. Best fitted near the amplifier	25

Coaxial cables

Coaxial cables for indoor installation, PVC sheath



Item		PAS4025202	PAS4036104	PAS4037104
Code	100 m		PAS4036104	PAS4037104
	200 m	289700		
Reel		Plastic	Plastic	Plastic
Inner conductor	Composition	Cu	Cu	Cu
	∅ mm	0.80	1.0	1.13
Dielectric	Composition	PEE	PEE	PEE
	∅ mm	3.5	4.7	4.85
Screen	Foil	AL/PET/AL	AL/PET/AL	AL/PET/AL
	%	100%	100%	100%
	Braid	CuSn	CuSn	AL
	%	40%	30%	35%
	Foil			
	%			
Antimigrating foil		PET	PET	PET
Sheath	Composition	PVC White	PVC White	PVC White
	∅ mm	5	6.7	6.8
ELECTRICAL PERFORMANCE				
Impedance @ 200MHz	Ohm	75 ± 3	75 ± 3	75 ± 3
Capacitance	pF/m	52	52	53
Velocity ratio		84%	84%	85%
Min. bending radius	mm	35	35	35
Attenuation @ 20°C dB/100mt				
MHz	5	2.0	1.6	1.5
MHz	50	5.9	4.6	4.3
MHz	200	11.3	9.0	8.4
MHz	470	17.6	14.5	13.6
MHz	800	23.3	18.6	17.2
MHz	1000	26.3	21.1	19.8
MHz	1350	30.8	25.0	23.3
MHz	1750	35.6	27.9	27.0
MHz	2150	40.0	31.7	30.6
MHz	2400	42.2	33.2	32.5
MHz	2700	45.2	35.8	35.0
Return loss dB				
MHz	50-470	>28	>30	>29
MHz	470-862	>26	>25	>25
MHz	862-1750	>20	>20	>20
MHz	1750-2400	>20	>20	>20
Screening efficiency dB				
MHz	5-30	>65	>65	>65
MHz	30-1000	>80	>75	>80
MHz	1000-2150	>85	>80	>70
DC Resistance				
Inner	Ohm/Km	35	22.5	21.5
Outer	Ohm/Km	33	31	27

Distribution

Coaxial cables Class A+

Coaxial cables for indoor installation, PVC sheath



Item		PAS4016102	PAS4017101	PAS4007111	PAS4009101
Code	100 m	PAS4016102	PAS4017101	PAS4007111	PAS4009101
Reel		Plastic	Plastic	Plastic	Plastic
Inner conductor	Composition	Cu	Cu	Cu	Cu
	∅ mm	1.0	1.13	1.13	1.7
Dielectric	Composition	PEE	PEE	PEE	PEE
	∅ mm	4.7	4.8	4.8	7.2
Screen	Foil	AL/PET/AL	AL/PET/AL	AL/PET/AL	AL/PET/AL
	%	100%	100%	100%	100%
	Braid	CuSn	CuSn	CuSn	CuSn
	%	40%	40%	40%	56%
	Foil			AL/PET	
	%			100%	
Antimigrating foil		PET	PET	PET	PET
Sheath	Composition	PVC White	PVC White	PVC White	PVC White
	∅ mm	6.7	6.8	6.8	10.2
Electrical performance					
Impedance @ 200MHz	Ohm	75 ± 3	75 ± 3	75 ± 3	75 ± 3
Capacitance	pF/m	52	52	52	52
Velocity ratio		84%	85%	85%	85%
Min. bending radius	mm	35	35	35	115
Attenuation @ 20°C dB/100mt					
MHz	5	1.6	1.3	1.3	0.8
MHz	50	4.6	4.3	4.1	2.6
MHz	200	9.0	8.4	8.0	5.4
MHz	470	14.5	13.4	12.6	8.5
MHz	800	18.6	17.2	16.8	11.0
MHz	1000	21.1	19.5	18.9	12.9
MHz	1350	25.0	23.0	22.3	15.2
MHz	1750	27.9	26.2	25.5	17.6
MHz	2150	31.7	29.5	28.7	19.8
MHz	2400	33.2	31.9	30.4	21.5
MHz	2700	35.8	33.0	32.8	23.2
Return loss dB					
MHz	50-470	>30	>30	>30	>30
MHz	470-862	>25	>28	>28	>28
MHz	862-1750	>20	>23	>25	>25
MHz	1750-2400	>20	>23	>20	>18
Screening efficiency dB					
MHz	5-30	>75	>75	>85	>80
MHz	30-1000	>85	>85	>95	>85
MHz	1000-2150	>85	>85	>90	>85
DC Resistance					
Inner	Ohm/Km	22.5	18	18	9
Outer	Ohm/Km	27	26	21	9.7

Coaxial cables Class A

Coaxial cables for indoor installation, PVC sheath



Item		PAS4136104	PAS4116102	PAS4117101	PAS4107111	PAS4109101
Code		PAS4136104	PAS4116102	PAS4117101	PAS4107111	PAS4109101
Reel	100 m	Plastic	Plastic	Plastic	Plastic	Plastic
Inner conductor	Composition	Cu	Cu	Cu	Cu	Cu
	Ø mm	1.0	1.0	1.13	1.13	1.7
Dielectric	Composition	PEE	PEE	PEE	PEE	PEE
	Ø mm	4.7	4.7	4.8	4.8	7.2
Screen	Foil	AL/PET/AL	AL/PET/AL	AL/PET/AL	AL/PET/AL	AL/PET/AL
	%	100%	100%	100%	100%	100%
	Braid	CuSn	CuSn	CuSn	CuSn	CuSn
	%	30%	40%	40%	40%	56%
	Foil	-	-	-	AL/PET	-
	%	-	-	-	100%	-
Antimigrating foil		PET	PET	PET	PET	-
Sheath	Composition	PE Black	PE Black	PE Black	PE Black	PE Black
	Ø mm	6.7	6.7	6.8	6.8	10.2
Electrical performance						
Impedance @ 200MHz	Ohm	75 ± 3	75 ± 3	75 ± 3	75 ± 3	75 ± 3
Capacitance	pF/m	52	52	52	52	52
Velocity ratio		84%	84%	84%	85%	85%
Min. bending radius	mm	35	35	35	35	115
Attenuation @ 20°C dB/100mt						
MHz	5	1.6	1.6	1.3	1.3	0.8
MHz	50	4.6	4.6	4.3	4.1	2.6
MHz	200	9.0	9.0	8.4	8.0	5.4
MHz	470	14.5	14.5	13.4	12.6	8.5
MHz	800	18.6	18.6	17.2	16.8	11.0
MHz	1000	21.1	21.1	19.5	18.9	12.9
MHz	1350	25.0	25.0	23.0	22.3	15.2
MHz	1750	27.9	27.9	26.2	25.5	17.6
MHz	2150	31.7	31.7	29.5	28.7	19.8
MHz	2400	33.2	33.2	31.9	30.4	21.5
MHz	2700	35.8	35.8	33.0	32.8	23.2
Return loss dB						
MHz	30-470	>30	>30	>30	>30	>30
MHz	470-862	>25	>25	>28	>28	>28
MHz	862-1750	>20	>20	>23	>25	>25
MHz	1750-2400	>20	>20	>23	>20	>18
Screening efficiency dB						
MHz	10-30	>65	>75	>75	>85	>80
MHz	30-1000	>75	>85	>85	>95	>85
MHz	1000-2150	>80	>85	>85	>90	>85
DC Resistance						
Inner	Ohm/Km	22.5	22.5	18	18	9
Outer	Ohm/Km	31	27	26	21	9.7

Distribution

Multicoax cables Class A



Item		PAS4004112	PAS4304102	PAS4004102	PAS4004109
Code		PAS4004112	PAS4304102	PAS4004102	PAS4004109
Reel	100 m	Wooden	Wooden	Wooden	Wooden
Inner conductor	Composition	Cu	Cu	Cu	Cu
	Ø mm	1.0	1.0	1	1.13
Dielectric	Composition	PEE	PEE	PEE	PEE
	Ø mm	4.7	4.7	4.7	4.8
Screen	Foil	AL/PET/AL	AL/PET/AL	AL/PET/AL	AL/PET/AL
	%	100%	100%	100%	100%
	Braid	CuSn	CuSn	CuSn	CuSn
	%	40%	40%	40%	40%
	Foil	-	-	-	-
	%	-	-	-	-
Internal Sheath	Composition	PVC 4 Colours	PVC 4 Colours	PVC 5 Colours	PVC 9 Colours
	Ø mm	6.6	6.6	6.6	6.6
External Sheath	Composition	PVC White	PVC White	PVC White	PVC Black
	Ø mm	19	19	20.5	25
Electrical performance					
Impedance @ 200MHz	Ohm	75 ± 3	75 ± 3	75 ± 3	75 ± 3
Capacitance	pF/m	52	52	52	52
Velocity ratio		84%	84%	84%	85%
Min. bending radius	mm	35	35	35	35
Attenuation @ 20°C dB/100mt					
MHz	5	1.6	1.6	1.6	1.3
MHz	50	4.6	4.6	4.6	4.3
MHz	200	9.0	9.0	9.0	8.4
MHz	470	14.5	14.5	14.5	13.4
MHz	800	18.6	18.6	18.6	17.2
MHz	1000	21.1	21.1	21.1	19.5
MHz	1350	25.0	25.0	25.0	23.0
MHz	1750	27.9	27.9	27.9	26.2
MHz	2150	31.7	31.7	31.7	29.5
MHz	2400	33.2	33.2	33.2	31.9
MHz	2700	35.8	35.8	35.8	33.0
Return loss dB					
MHz	30-470	>30	>30	>30	>30
MHz	470-862	>25	>25	>25	>28
MHz	862-1750	>20	>20	>20	>23
MHz	1750-2400	>20	>20	>20	>23
Screening efficiency dB					
MHz	10-30	>75	>75	>75	>75
MHz	30-900	>85	>85	>85	>85
MHz	900-2150	>85	>85	>85	>85
DC Resistance					
Inner	Ohm	22.5	22.5	22.5	18
Outer	Ohm	27	27	27	26

Index of products

Item	Code	Page	Item	Code	Page	Item	Code	Page
10BL45F	219446	30	BLU 10HD	217902	23	CF66B	287191	145
10BL4F	219406	30	BLU 10HD LTE	217909	18	CF70B	287192	145
10BL5F	219407	30	BLU 22HD	217905	23	CFR50B	287193	145
10F2734	219532	29	BLU 5	217906	24	CFR60B	287194	145
10F3546	219541	29	BLU 5HD	217901	23	CFR66B	287195	145
10RD45F	219546	31	BLU 5HD LTE	217910	18	CONTROPIASTRA	287291	41
3DG-2ASI-2T	283160	71	BLU COMBO LTE	217911	33	CR75I	289776	146
3DG-2S2-2T	283157	71	BLV4F	218038	15	CV-RCA/HQ	289852	96
3DG-2T2-2T	283159	71	BLV6F	218058	15	CVDC50	280376	86
3DG-BOX	283156	71	BOC	220801	133	CVMS-EU	280005	130
3DG-BOX-PC	183161	71	BR2-AA	289360	104	CWDM 5 DEMUX	287342	101
3DG-FRONT PANEL	283158	71	BR4-AA	289362	104	CWDM 5 MUX	287341	101
4AL827	4AL827	107	BT-AX	287126	141	D-MATRIX 4S	283131	67
4E512_F	218706	13	BT-AX2	287127	141	D-MATRIX 4S EVO	283132	68
4GKILLER	226710	48	BT-AXB	289738	141	D-MATRIX 8T	283133	69
4SC/APC CONN	287345	104	BT-AXB2	289740	141	DAB	213010	12
6E512_F	218718	13	BT-AXS	289737	141	DE1-10	280710	135
8SC/APC CONN	287347	104	BT-AXS2	289739	141	DE1-14	280711	135
AB-CH	280831	142	BT-INT	280754	141	DE1-18	280712	135
AB-CH2	280832	142	BT-INT2	280801	141	DE1-22	280713	135
AFI112T	223230	54	BT-LIG	280752	141	DE2-10	280714	136
AFI121T	223231	54	BT-LIG2	280802	141	DE2-14	280715	136
AFI122T	223233	54	BT-LIGT	280699	141	DE2-18	280716	136
AFI123T	223235	54	BT-LIGT2	280803	141	DE2-22	280717	136
AFI123W	223237	54	BT-LIV	280753	141	DE4-12	280718	136
AFI313T	223236	54	BT-LIV2	280805	141	DE4-14	280719	136
ALPHA 3HD	213211	25	BT-LU	280756	141	DE4-18	280720	136
ALPHA 5HD	213212	25	BT-LU2	280806	141	DE4-22	280721	136
ALPHA3LTE+	213220	19	BT-MA	280755	141	DE6-16	280722	136
ALPHA5LTE+	213221	19	BT-MA2	280804	141	DE6-20	280723	136
AM100N	289113	53	BT-MAT	280757	141	DE8-16	280725	136
AM200N	289119	53	BT-MAT2	280807	141	DE8-20	280726	136
AM50N	289112	53	CA2	219602	41	DFAN	289487	46
AMP2000/UK	271140	126	CA75F	289085	146	DF0100C	289294	46
AMP9254	271031	123	CAD11	220451	134	DF0120N	289199	46
AMP9254A	271033	123	CAD12	220452	134	DFP85	211001	42
AMP9294	271032	123	CAD13	220453	134	DFP85R	211002	42
AMP9564	228371	60	CAD14	220454	134	DFPDIGIT	211003	42
AMP9762	235051	60	CAPL	280741	143	DGTX10	211111	42
AMP9762B	235055	60	CAPPUCCIO PVC	287294	41	DGTX10-A	211112	42
AMP9763	235052	60	CAV8	287282	40	DGTX10-GA	211116	42
AMP9763B	235056	60	CAV8DIST	287280	40	DIGIT	211101	42
AMP9764	235053	60	CAV8UNIVERSAL	287281	40	DIGIT-A	211104	42
ANI	293108	41	CCF102	289769	145	DIGIT-G	211102	42
ANT1200A	213001	12	CCF66	289768	145	DIGIT-GA	211105	42
AR20F	287202	146	CCOM F10.5	287297	145	DIGIT-R	211103	42
ARD	220891	133	CCOM F5.1	287301	145	DIGIT-RA	211106	42
AS20	284013	46	CCOM F5.1 S	287295	145	DSQ21J	289588	46
AT14LTE59	226712	50	CCOM IEC6F	287298	146	DSQ41J	289589	46
AT14LTE69	226713	50	CCOM IEC6M	287300	146	ESI/Q	226905	50
AV-SBA	280745	142	CDI-10	220810	132	ESI/RVU	226909	50
AV-SBA2	280817	142	CDI-14	220814	132	ES2/Q	226913	50
AV-SBL	280746	142	CDI-18	220818	132	ES2/RU	226917	50
AV-SBL2	280818	142	CDI-22	220822	132	ES2RT	226912	50
AV-SN02	280816	142	CDI1	220660	134	ESV45	226804	49
AV-SN0	280743	142	CDI2	220670	134	ESVU	226801	49
AZ0120-PP	289949	44	CDI44	220654	134	ESVUU	226806	49
AZ0120N	289196	44	CD2-10	220830	132	FEB	287203	130
AZ0150	289140	44	CD2-14	220834	132	FHM	289888	96
BA6	293400	41	CD2-18	220838	132	FIL10	272108	61
BA914	280674	41	CD2-22	220842	132	FM FILTER	226714	48
BFO-SC-APC	289349	104	CD4-12	220852	133	FM OMNI	213009	12
BIC	220800	133	CD4-14	220854	133	FRPRO10	272102	62
BLU 10	217907	24	CD4-18	220858	133	FRPRO10 HD	272110	62
BLU 10B4	217903	23	CF50B	287189	145	GCI	290030	146
BLU 10B5	217904	23	CF60B	287190	145	GCF	289544	146

Index of products

Item	Code	Page	Item	Code	Page	Item	Code	Page
GW-CB	280837	142	KRX-RC	270672	103	MAP541LTE	223509	51
GW-CB2	280838	142	KSP1_2	270679	104	MAP541LTE/..	223515	51
GW-CN	280835	142	KSP1_4	270680	104	MAP541LTE/40-42	223525	51
GW-CN2	280836	142	KTX	270686	103	MBJ2331LTE	223416	58
GW-CT	280833	142	KTX-RC	270671	103	MBJ2340/..	223414	58
GW-CT2	280834	142	KW20D	270049	84	MBJ2340/40-42	223417	58
GW-PL	280797	142	KW33B	270050	84	MBJ2340LTE	223411	58
GW-PL2	280813	142	KW33C	270053	84	MBJ2356	223313	58
GW-SYB	280796	142	KW35D	270061	84	MBJ2510LTE	223418	58
GW-SYB2	280814	142	KW35E	270059	84	MBJ2557	223300	58
GW-SYw	280798	142	KW44C	270051	84	MBJ2640	223336	58
GW-SYw2	280815	142	KX125	282104	83	MBJ2640LTE	223412	58
ICP/UU	223367	57	KX125E	282106	83	MBJ2640LTE/..	223415	58
IP2	220322	134	KX125NT	282105	83	MBJ3610	223409	58
J21B	223023	58	LAMBDA 14 LTE	213058	21	MBJ3620	223333	58
J31B	223024	58	LAMBDA 9 LTE	213057	21	MBJ3631	223322	58
JS2RT	226905	50	LG-CR	280747	142	MBJ3640LTE	223410	58
JSVU3	226804	49	LG-CR2	280820	142	MBJ3656	223328	58
K120/FM	270271	76	LG-VEC	280799	142	MBX0001	235000	59
K120L/B3	270885	76	LG-VEC2	280822	142	MBX5540LTE	235109	59
K120L/xxDT	2708xxDT	76	LG-VES	280800	142	MBX5540LTE/..	235113	59
KCPN	282618	81	LG-VES2	280821	142	MBX5541LTE	235111	59
KD100N	270002	86	LP345F	216170	34	MBX5710	235025	59
KDF	282646	78	LP345HV	216168	37	MBX5720	235021	59
KDSR	270624	79	LP345MF	216169	34	MBX5740LTE	235108	59
KDSR-M	270622	79	LP34F	216135	35	MBX5740LTE/..	235112	59
KDSR-S	270623	79	LP3F	216171	36	MBX5741LTE700	235115	59
KDTR	270619	80	LP45F	216149	35	MBX5741LTEUK	235114	59
KFB3	270063	77	LP45MINI	216150	35	MBX5851	235016	59
KFB4	270054	77	LP45NF	216150	35	MBX7740/35-36	235105	59
KFB5	270055	77	LP4F	216151	36	MBX7741	235006	59
KFB5/..	270062	77	LP5F	216108	36	MCP/UU	223366	57
KFBU	270064	77	LPV345F	217350	34	MIN/MIN	287225	102
KFT/.	282614	83	LPV345HV	217349	37	MINIBOOST	270025	54
KFT/..	282615	83	LTE FILTER 48	226715	48	MINIPOWER12	270021	53
KFT/...	282616	83	LTE FILTER 59	226711	48	MINIPOWER12P	270020	53
KIF/S2	282589	83	LTE FILTER 60	226709	48	MINIPOWER24	270024	53
KIT 1 LTE	217921	53	MAK2331LTE	223389	52	MINIPOWER24P	270023	53
KIT 10 LTE	217930	53	MAK2340LTE	223393	52	MOD-HDTV	287400	55
KIT 11 LTE	217931	53	MAK2340LTE/.	223390	52	MOD90	280001	56
KIT 12 LTE	217932	53	MAK2340LTE/40-42	223388	52	MOD90R	280002	56
KIT 13 LTE	217933	53	MAK2510LTE	223387	52	MOD90S	287058	56
KIT 2 LTE	217922	53	MAK2640LTE	223392	52	MP45AF	236507	86
KIT 3 LTE	217923	53	MAK2640LTE/.	223391	52	MPCCF	236508	86
KIT 4 LTE	217924	53	MAP102	223121	52	MX201	223201	48
KIT 5 LTE	217925	53	MAP106	223122	51	MX202	223201	48
KIT 6 LTE	217926	53	MAP110	223196	52	MX203	223201	48
KIT 7 LTE	217927	53	MAP111	223506	52	MX205	223217	48
KIT 8 LTE	217928	53	MAP113LTE	223513	51	MX206	223218	48
Kit 9/10 R080	211319	46	MAP113LTE24	223516	52	MX210	223222	48
KMM	270632	82	MAP115LTE	223523	51	MX210.*	223223	48
KMS	270631	82	MAP116I	223507	52	MX211	223221	48
KMTW	270633	82	MAP201LTE	223512	52	MXST	226400	49
KP15	270018	84	MAP204LTE	223511	51	NASTROZNF	287263	41
KP35	270017	84	MAP206LTE	223520	51	OMEGA 8	213022	26
KP62	270019	84	MAP207LTE	223524	51	OPC 4 ARM	287344	104
KPN51	289244	86	MAP208	223161	51	OPC 8 ARM	287346	104
KPR37	289485	85	MAP210/31-33	223523	51	OPT TX-1510	270667	100
KPR41	289486	85	MAP300LTE	223521	52	OPT TX-1530	270668	100
KPR52	289491	85	MAP303/31-33	223128	51	OPT TX-1550	270669	100
KRF15	289537	85	MAP313LTE	223511	51	OPT TX-1570	270670	100
KRF16A	280009	85	MAP315LTE	223522	51	OPT TX-DT	270694	100
KRF32A	280010	85	MAP401	223195	51	OPT-RX 4 MINI	270666	101
KRF45	289538	85	MAP413LTE	223510	51	OPT-RX DT	270693	101
KRS-RJ	282732	85	MAP540LTE	223508	51	OPT-RX TV	270696	101
KRX	287677	103	MAP540LTE/..	223514	51	OPT-RX51	270690	103

Item	Code	Page
OPT-TX51	270689	103
OPTATT3DB	287239	102
OPTATT4DB	287237	102
OPTATT7DB	287238	102
P80APK	211308	46
P80APN	211316	43
P85AK	211220	46
P85GX10-A	211217	42
P85GX10-B	211212	42
P85RX10-A	211216	42
P85RX10-B	211211	42
P85X10	211209	42
P85X10-A	211210	42
PA2	280701	135
PA3	280703	135
PA4	280702	135
PA6	280704	135
PA8	280705	135
Pal curva40+att	287258	38
Pal curva50+att	287259	38
PaloCB2 1,5/30	287247	38
PaloCB2 1,5/35	287248	38
PaloCB2 1,5/40	287249	38
PaloCB2 2/35	287250	38
PaloCB2 2/42	287251	38
PaloCB2 2/50	287252	38
PaloCB2 3/60	287256	38
PaloCB3 2/35	287253	38
PaloCB3 2/42	287254	38
PaloCB3 2/50	287255	38
PaloCB3 3/60	287257	38
PaloSB2 1,5/25	287244	38
PaloSB2 2/28	287245	38
PaloSB3 2/28	287246	38
PAS0023311	PAS0023311	144
PAS0023411	PAS0023411	144
PAS0032	PAS0032	144
PAS00322	287103	144
PAS0032D	PAS0032D	144
PAS0042	PAS0042	144
PAS0042D	280793	144
PAS0303011	PAS0303011	49
PAS3213001	PAS3213001	146
PAS3236Q	PAS3236Q	146
PAS4004102	PAS4004102	150
PAS4004109	PAS4004109	150
PAS4004112	PAS4004112	150
PAS4007111	PAS4007111	148
PAS4009101	PAS4009101	148
PAS4016102	PAS4016102	148
PAS4017101	PAS4017101	148
PAS4025202	289700	147
PAS4036104	PAS4036104	147
PAS4037104	PAS4037104	147
PAS4107111	PAS4107111	149
PAS4109101	PAS4109101	149
PAS4116102	PAS4116102	149
PAS4117101	PAS4117101	149
PAS4136104	PAS4136104	149
PAS4304102	PAS4304102	150
PAS6106	289770	146
PAUTV	280373	146
PC8338	287398	130
PDM00	220003	140
PDM05	220002	140
PDM10	220001	140

Item	Code	Page
PDM14	220004	141
PDM18	220005	141
PDM22	220006	141
PENTA85	211201	42
PENTA85-A	211205	42
PENTA85G	211203	42
PENTA85G-A	211206	42
PENTA85R	211204	42
PENTA85R-A	211207	42
PL1	280736	142
PL2	280737	143
P060APX5	287185	43
P080SCX50	287402	43
PPI2	220370	134
PPI2DC	220375	134
PPI3	220376	134
PPI4	220390	134
PPI4DC	220392	134
PP2	220802	132
PP3	220803	132
PP4	220804	132
PP5	220805	132
PR ADAPT	287226	102
PR003	287219	102
PR005	287220	102
PR010	287221	102
PR025	287222	102
PR035	287327	102
PR050	287328	102
PR075	287329	102
PR1	290451	145
PR100	287223	102
PR11	290365	145
PR5	290454	145
PR100	280730	143
PR106	280731	143
PR110	280732	143
PR114	280733	143
PR118	280734	143
PR122	280735	143
PRT1	210095	146
PSU1315TS	287375	126
PSU1340TS	287376	126
PSU3001	271160	126
PSU3001/UK	271159	126
PSU342	289564	53
PSU412	289562	53
PSU511	289851	53
PT100AC	289293	44
PT100C	289291	44
PU16F	217436	32
PU4AF	217423	32
PU4F	217424	32
PUBF	217428	32
PULL CONN	287224	102
PV10	210011	41
PVP	210002	41
RACK01	289708	97
RACK02	289709	97
RACK03	289710	97
RACK04	289711	97
RACK05	289712	98
RACK06	289713	98
RACK07	289714	98
RACK08	289715	98
RACK09	289716	98

Item	Code	Page
RACK10	289717	98
RACK11	289718	98
RACK12	289719	98
RACK27U	289721	97
RACK42U	289722	97
RACK6U	289720	97
RALLATRIS	287289	41
RO100ACX6	289299	44
RO100APX5G	289830	44
RO120N	289197	44
RO125APX3G	289832	44
RO150	289139	44
RO60APX400	287186	43
RO60AX10	280610	43
RO80APN	211316	43
RO80APX200	289283	43
RO80APX50	287479	43
RO85APX5G	289828	43
SAF-HD 10	272008	65
SAF-HD 7	272009	65
SAT21601	211311	46
SCD2-4216	271129	122
SCP3	287399	130
SCR414SKY	271127	121
SCR41S	287218	45
SCR5431T	287334	121
SCR5831T	287335	121
SCR583UK	287336	121
SCR8514	271121	121
SI2	220872	133
SI3	220873	133
SI4	220874	133
SIG7100	283949	89
SIG7120	283950	91
SIG7121	283953	91
SIG7281	283933	90
SIG7282	283943	90
SIG7282S	283944	90
SIG7330	283954	89
SIG7340	283955	89
SIG7400	270678	94
SIG7404H	287348	92
SIG7531	283952	88
SIG7540	283951	88
SIG7600HTX	270678	104
SIG7622	270687	94
SIG7624	270688	94
SIG7710	283945	93
SIG7720	283947	93
SIG7730	283946	93
SIG7802HD	287349	92
SIG7900	283935	95
SIG7901	283930	95
SIG7903	283928	95
SIG7904	283927	95
SIG9506	283126	73
SIG9708CI	283141	75
SIGMA 6HD	213201	22
SIGMA 6HD LTE	213219	20
SIGMA 6HD LTE700	213224	20
SIGMA 6PWR HD	213209	22
SIGMA 8HD LTE	213213	20
SIGMA 9HD	213208	22
SIGMA COMBO LTE	213223	33
SIGMA PWR HD	213204	22
SIGMA V2 HD	213203	16

Index of products

Item	Code	Page	Item	Code	Page	Item	Code	Page
SP1	290351	145	SWI8532STPLUS	271058	114	VI-ARK-B	287331	142
SP5	290354	145	SWI85SPL2	271096	129	VI-ARK-W	287330	142
SPF00	220721	140	SWI85TI5	271095	129	VI-ARK2-B	287304	142
SPF05	220722	140	SWI8908PLUS	271067	115	VI-ARK2-W	287303	142
SPF10	220723	140	SWI8912PLUS	271068	115	VI-EKB	289741	141
SPF14	220724	140	SWI8916PLUS	271069	115	VI-EKB2	289742	141
SPF18	220725	140	SWI908DC	271118	110	VI-EKN	289798	141
SPF22	220726	140	SWI908TS	287360	116	VI-EKN2	289799	141
SPI00	220711	139	SWI912TS	287361	116	VI-EKW	280839	141
SPI05	220712	139	SWI916DC	271119	110	VI-EKW2	280840	141
SPI10	220713	139	SWI916TS	287362	116	VI-ID	280749	141
SPI14	220714	139	SWI924TS	287363	116	VI-ID2	280810	141
SPI18	220715	139	SWI932TS	287364	116	VI-IDB	280748	141
SPI22	220716	139	SWPI708TS	287355	109	VI-IDB2	280811	141
SPS1750	289087	126	SWPI712TS	287356	109	VI-PL	280751	142
SPTR2	287305	137	SWPI716TS	287357	109	VI-PL2	280812	142
SPTR3	287306	137	SWPI724TS	287358	109	VI-PLS	287121	142
SPTR4	287307	137	SWPI732TS	287359	109	VI-PLS2	287122	142
SPTR6	287308	137	SWP908TS	287350	108	VOT 1/2	287215	102
SPTR8	287309	137	SWP912TS	287351	108	VOT 2/3	287216	102
STMI	281801	41	SWP916TS	287352	108	VOT 3/4	287217	102
SUPCURVO180G	287267	41	SWP924TS	287353	108	VOT 7/3	287212	102
SUPMUR026	287265	41	SWP932TS	287354	108	VOT 8/3	287213	102
SUPMUR046	287266	41	T75IF	290002	146	VOT 9/1	287214	102
SUPP VOV/VOT	287240	102	TAPSI10	287310	137	VOV 2	287210	102
SUPUNIVERSAL	287264	41	TAPSI15	287311	137	VOV 4	287211	102
SWA1730TS	287347	125	TAPSI20	287312	137	WDM 2	287343	101
SWA5122	271035	125	TAPS212	287313	138	ZN3PREG	287272	39
SWA5414	271036	125	TAPS215	287314	138	ZNC85X10	211208	42
SWA5424	271034	125	TAPS220	287315	138	ZNCAMINO	287287	40
SWA930TS	287373	125	TAPS412	287316	138	ZNCDGTX10	211110	42
SWI1308TS	287365	117	TAPS415	287317	138	ZNECON010	287279	40
SWI1312TS	287366	117	TAPS420	287318	138	ZNECON05	287333	40
SWI1316TS	287367	117	TAPS616	287319	138	ZNESPT010	287268	39
SWI1401B	271072	130	TAPS620	287320	138	ZNESPT015	287269	39
SWI1708TS	287368	118	TAPS616	287321	139	ZNESPT020	287270	39
SWI1712TS	287369	118	TAPS820	287322	139	ZNESPTU10	287260	39
SWI1716TS	287370	118	TAU LTE KILLER	213013	17	ZNESPTU15	287261	39
SWI1724TS	287371	118	TAU LTE KILLER +	213014	17	ZNESPTU20	287262	39
SWI1732TS	287372	118	TAU11/4	213096	27	ZNFRCAM32	287284	40
SWI39AT	271020	129	TAU11/45	213101	27	ZNFRCAMNEW28	287285	40
SWI4404-00	271081	111	TAU11/5	213097	27	ZNMURO	287288	40
SWI4404-08	271082	111	TAUI5/4	213094	28	ZNO100C	289285	44
SWI4404-17	271083	111	TAUI5/45	213100	28	ZNO100PX5	289831	44
SWI4406-00	271084	111	TAUI5/5	213095	28	ZNO125PX3	289833	44
SWI4406-08	271085	111	TCOM all size	287299	146	ZNO60AC	289279	43
SWI4406-17	271086	111	TCOM pocket	287296	146	ZNO60AP	287187	43
SWI4408-00	271087	111	TEGOLAPIOMBO	287293	41	ZNO80APN	289480	43
SWI4408-08	271088	111	TEGOLAPVC	287292	41	ZNO85PX5G	289829	43
SWI4408-17	271089	111	TEL1.5/4	287243	38	ZNPMECONO	287274	39
SWI44SP2	271091	129	TEL2/4	287241	38	ZNPMEMILIA	287273	39
SWI44TI5	271092	129	TEL2/6	287242	38	ZNRINF	287275	39
SWI4508DT	271148	106	TENDIFILO	287290	41	ZNRINF 10	287277	39
SWI4512DT	271149	106	TERZA 6HD	213008	14	ZNRINF 20	287278	39
SWI4516DT	271150	106	TF90	289543	146	ZNRINF 5	287276	39
SWI4524DT	271151	106	TPE	282733	85	ZNRING	287271	39
SWI4532DT	271152	106	UX-MBQD6	287141	45	ZNSOLAI	287283	40
SWI504SA	271161	112	UX-MBS6	287139	45	ZNTELE20	287332	40
SWI506SA	271162	112	UX-MBTW6	287140	45	ZPL-R450	287180	41
SWI508DC	271115	110	UX-OCTO LTE	287340	45	ZPL-R650	287179	41
SWI508SA	271163	112	UX-QD LTE	287339	45			
SWI516DC	271117	110	UX-QT LTE	287302	45			
SWI8508PLUS	271055	114	UX-S LTE	287337	45			
SWI8512PLUS	271056	114	UX-TW LTE	287338	45			
SWI8516PLUS	271063	114	VI-80	280750	141			
SWI8524STPLUS	271057	114	VI-802	280809	141			

Fracarro Radioindustrie SRL
Via Cazzaro, 3
31033 Castelfranco Veneto (TV)
Italy
Tel. +39 0423 7361
Fax +39 0423 736220
www.fracarro.com
info@fracarro.com

